

**3M**

**PELTOR™**

# Tactical Modular Audio System

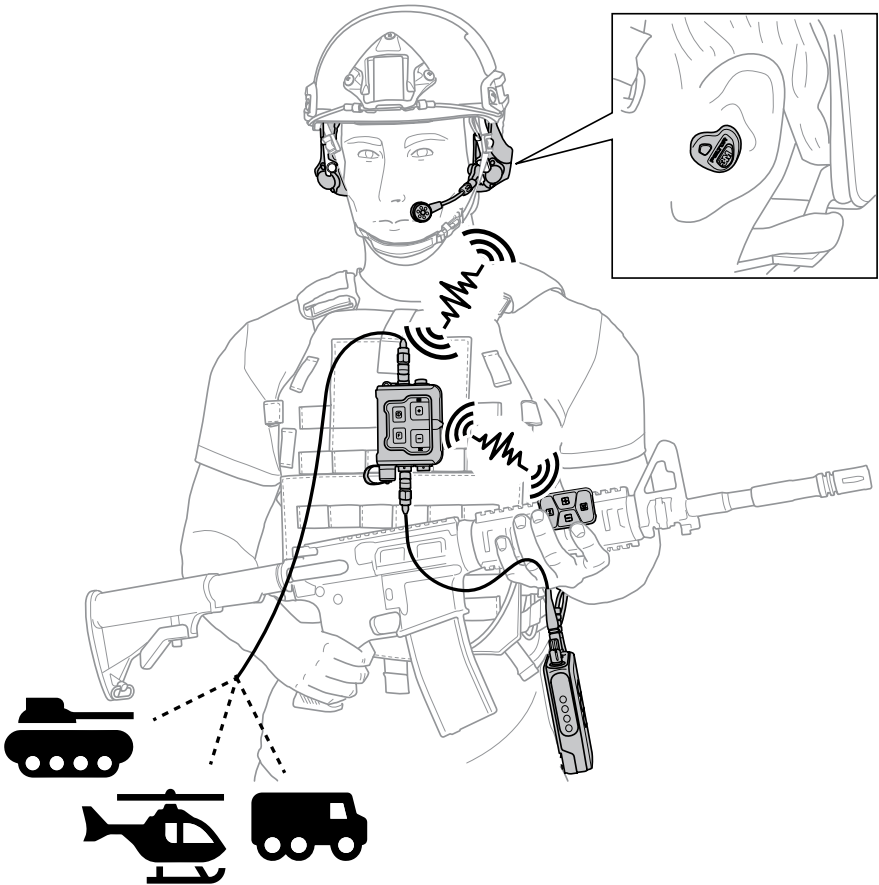



### **Important Read First!**

Please read and follow this document in conjunction with the User Instructions for your relevant components: 3M™ SCU/RCU-300, 3M™ ComTac™ VII Headset, and/or 3M™ Tactical Earplug TEP-300. Pay particular attention to warning statements.



### **¡Importante, leer primero!**

Leer y seguir las indicaciones de este documento junto con el manual de instrucciones de los componentes relevantes.

3M™ SCU/RCU-300, 3M™ ComTac™ VII Headset, y/o 3M™ Tactical Earplug TEP-300. Prestar especial atención a las advertencias.



### **Important à lire en premier !**

Veillez lire et vous conformer au présent document et à la notice d'utilisation de vos composants concernés conjointement :

3M™ SCU/RCU-300, 3M™ ComTac™ VII Headset, et/ou 3M™ Tactical Earplug TEP-300. Accordez une attention particulière aux avertissements.



### **Unbedingt zuerst lesen!**

Lesen und befolgen Sie bitte dieses Dokument zusammen mit der Gebrauchsanleitung der für Sie relevanten Teile: 3M™ SCU/RCU-300, 3M™ ComTac™ VII Headset, und/oder 3M™ Tactical Earplug TEP-300. Bitte beachten Sie insbesondere die Warnhinweise.

# 3M™ PELTOR™ Tactical Modular Audio System

EN	17-37
ES	38-58
FR	59-79
DE	80-100

# QUICK START GUIDE FOR TACTICAL MODULAR AUDIO SYSTEM

## OVERVIEW

<b>A</b>	TEP-300
<b>B</b>	COMTAC™ VII
<b>C</b>	SCU-300
<b>D</b>	RCU-300

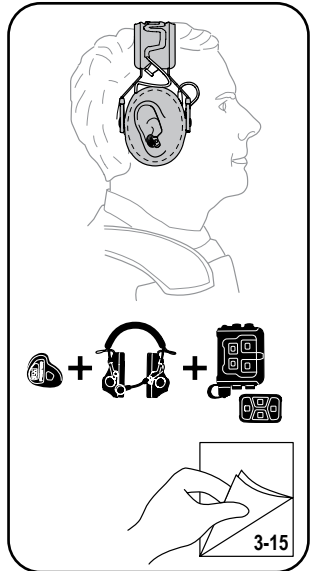
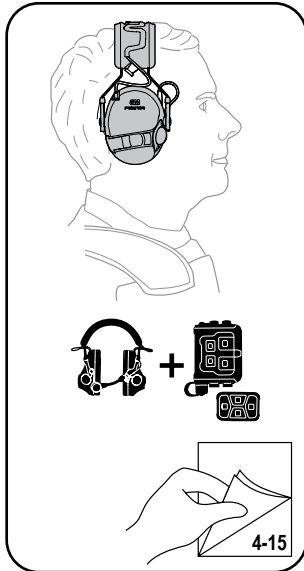
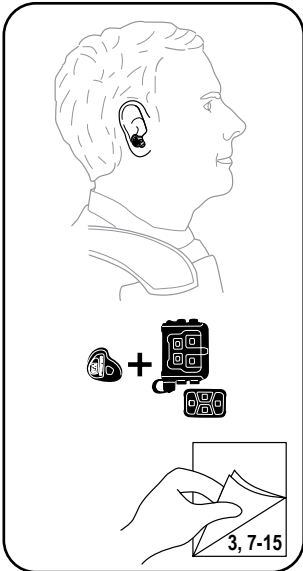
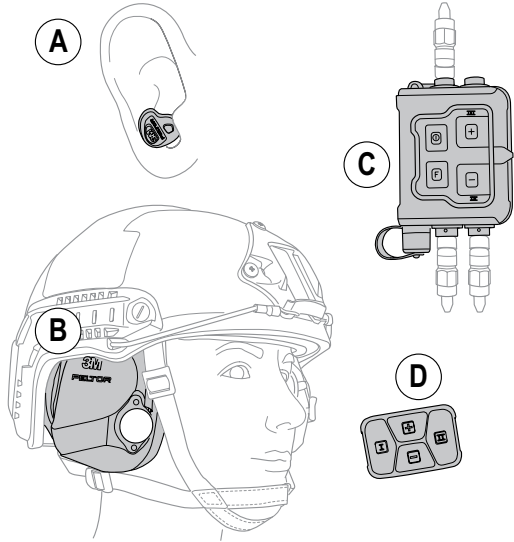

# TEP-300

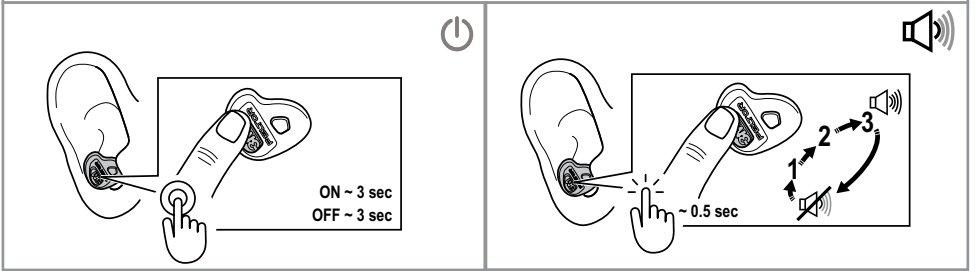
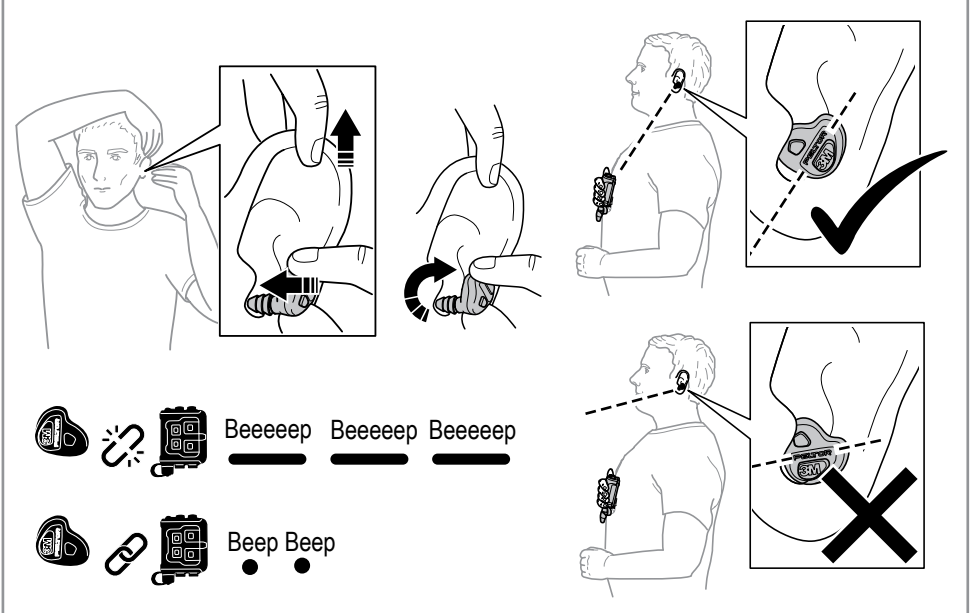
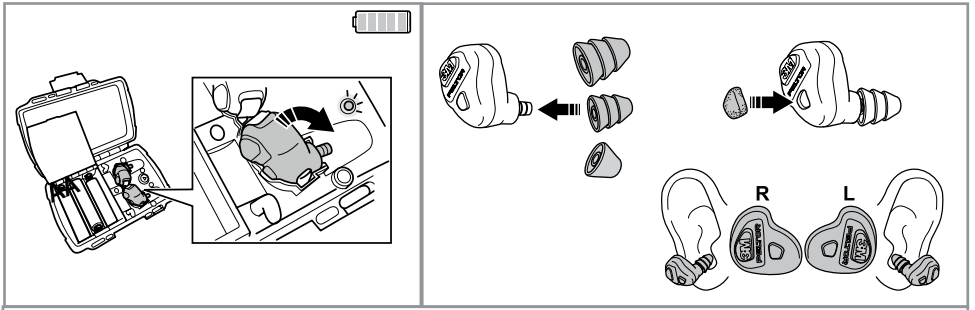

# COMTAC™ VII

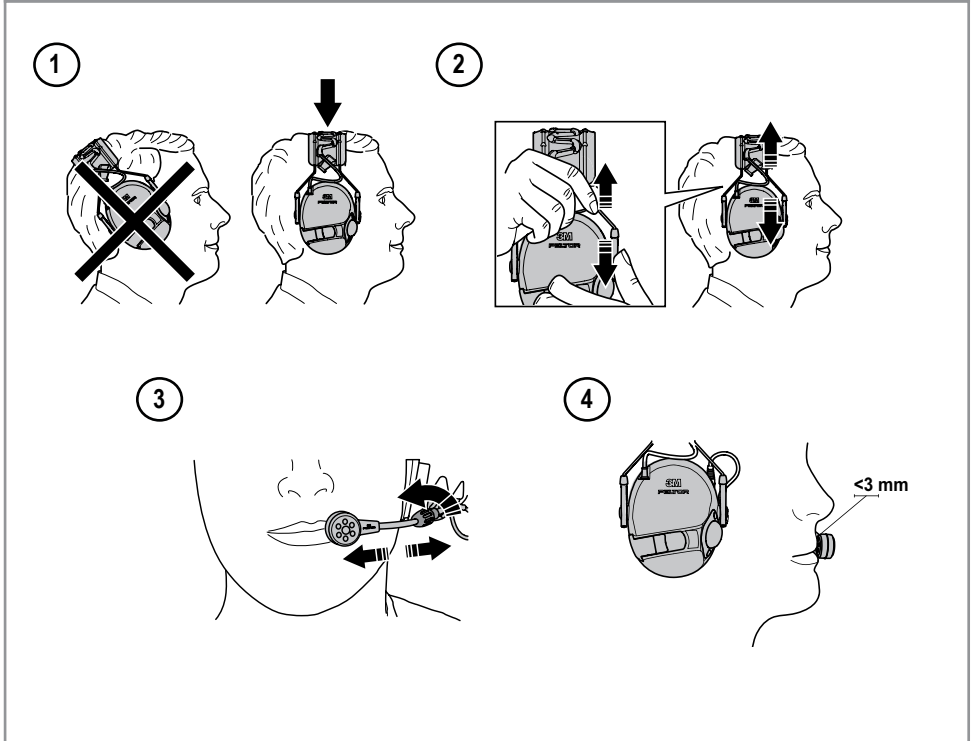
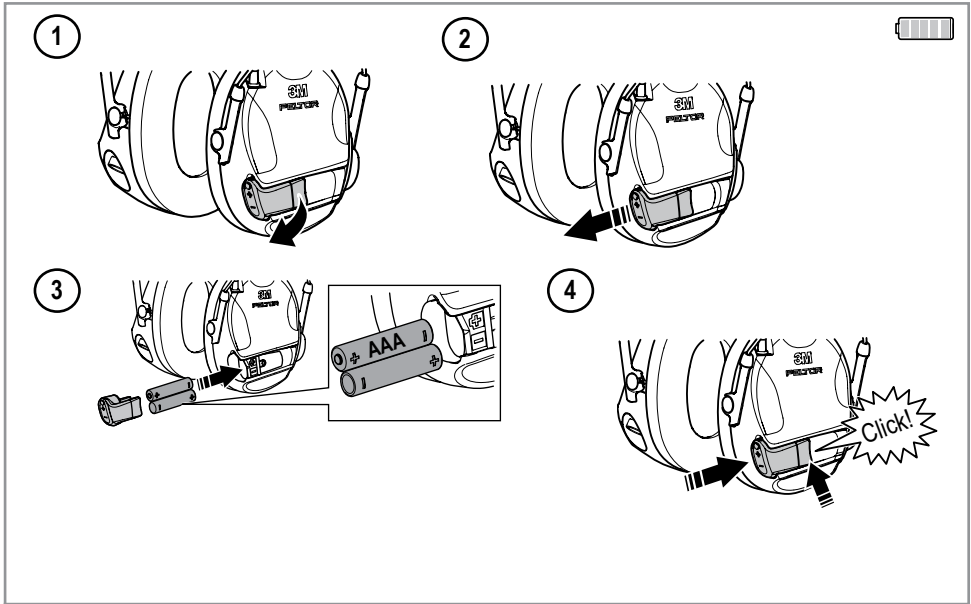

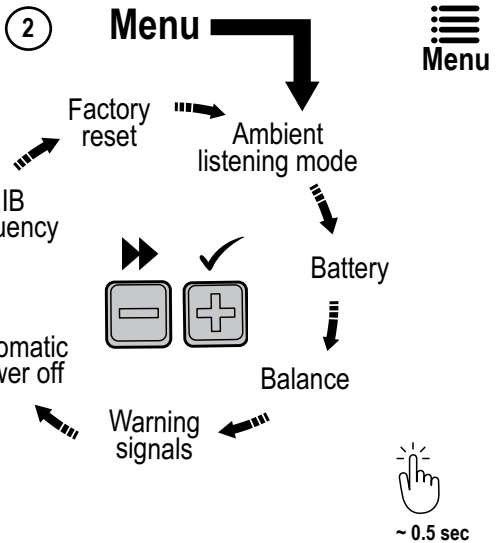
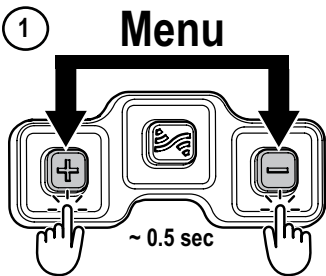
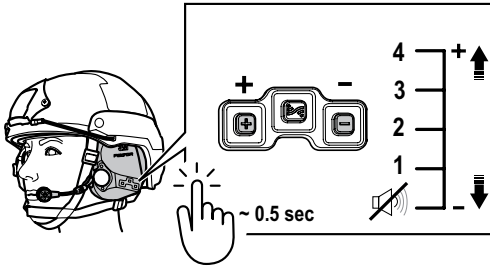
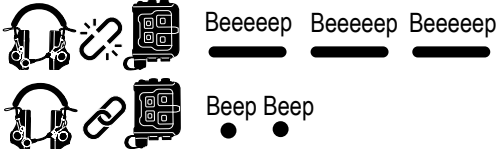
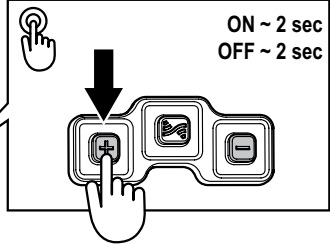
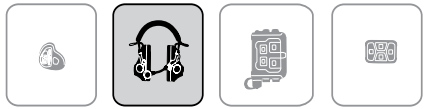

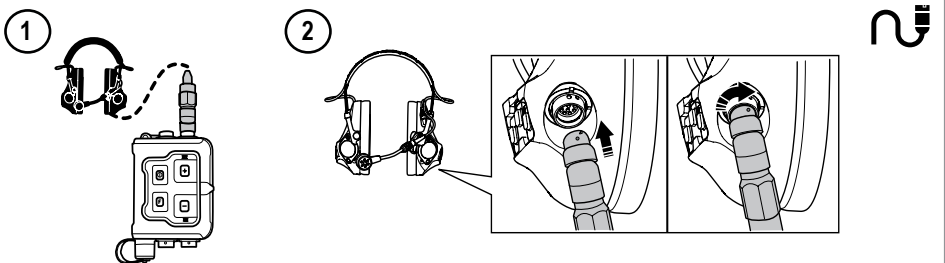
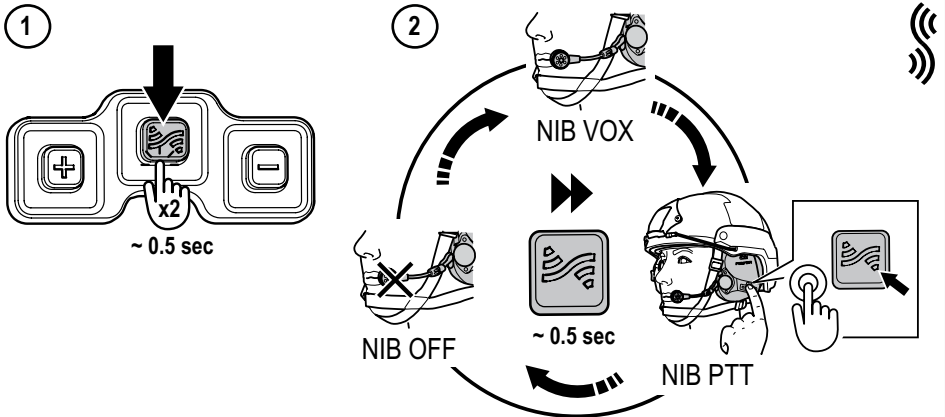
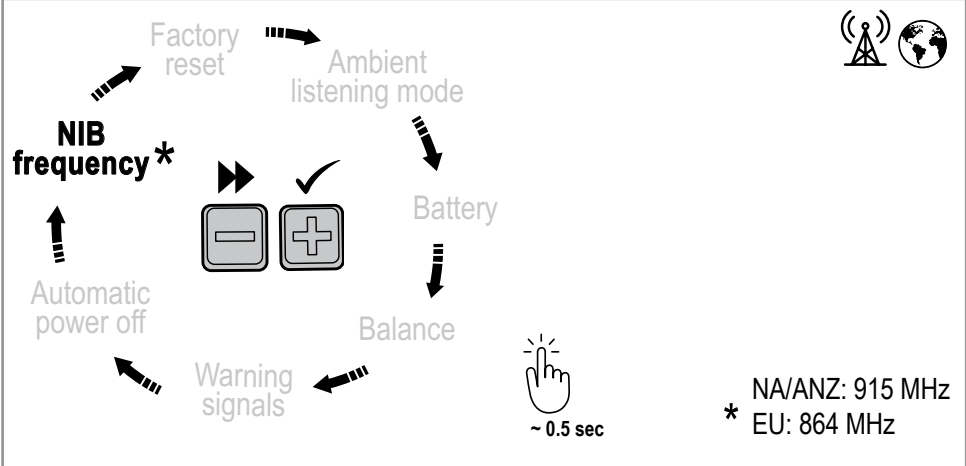



# SCU-300

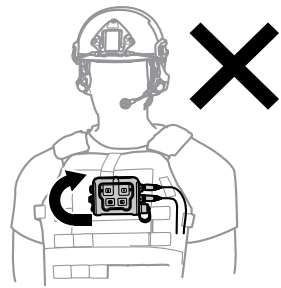
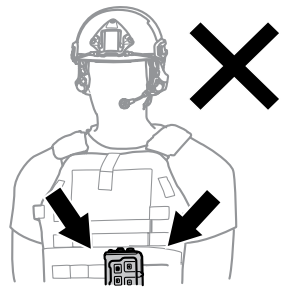
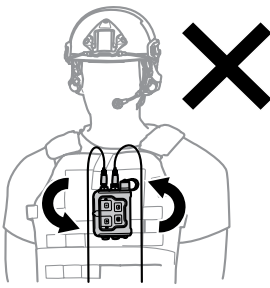
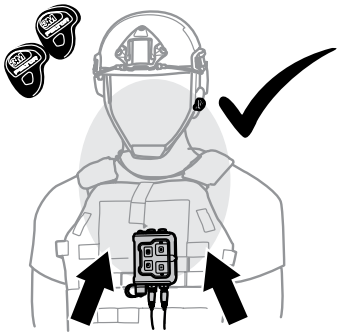
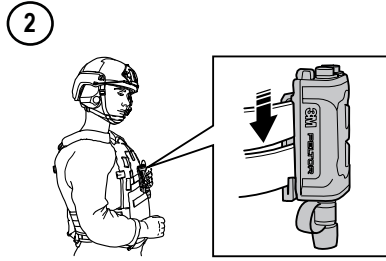
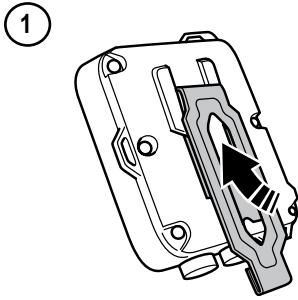
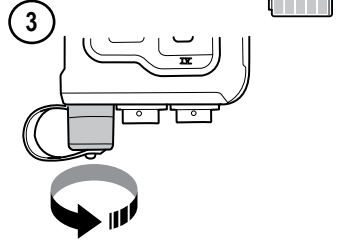
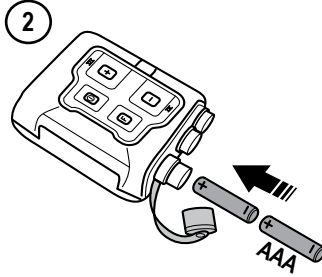
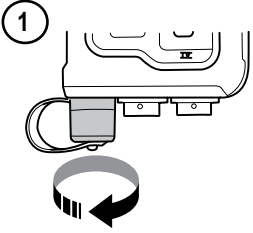

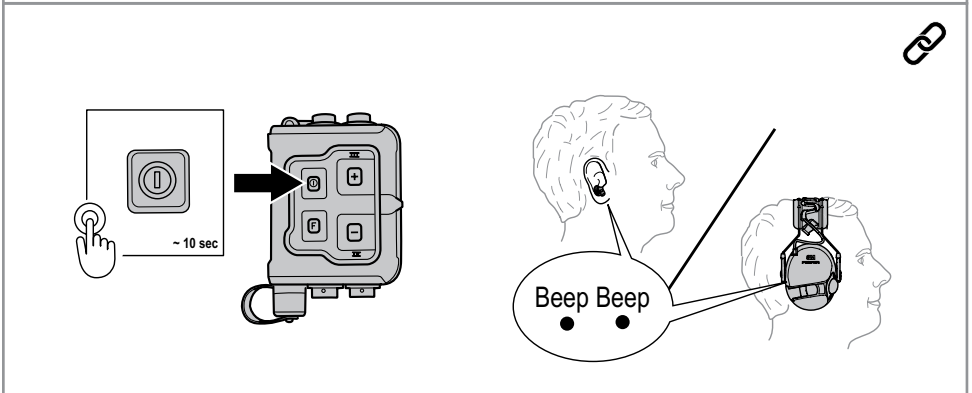
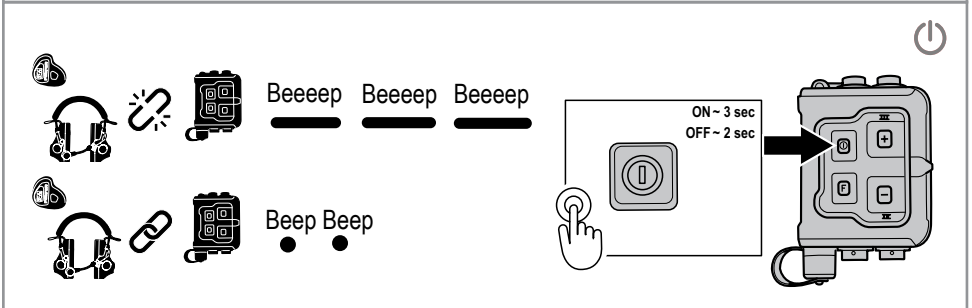
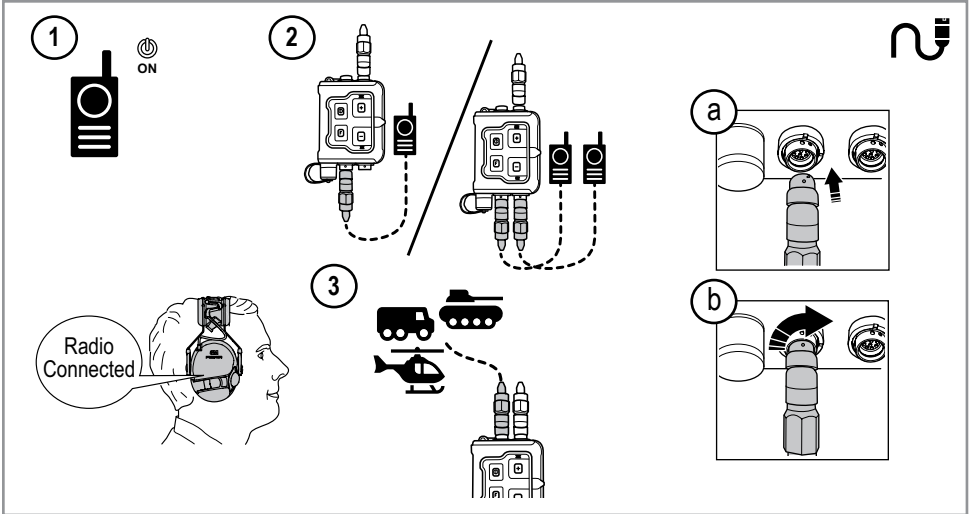

# RCU-300

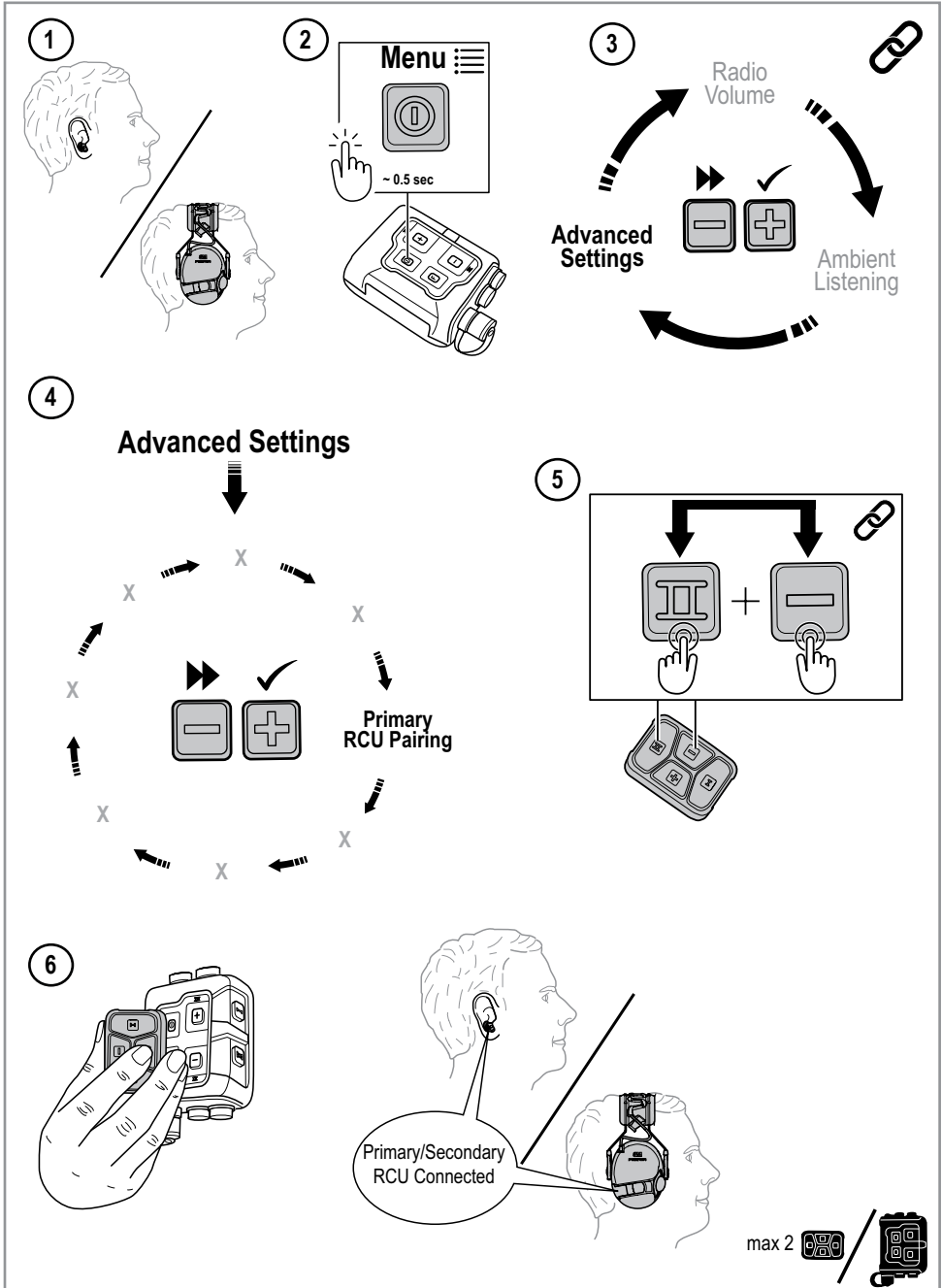



1

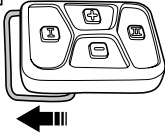
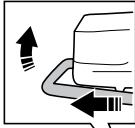

2

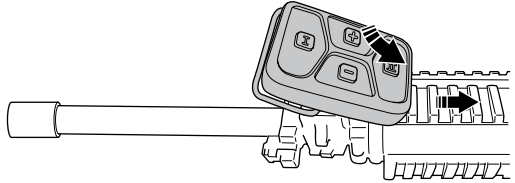

3

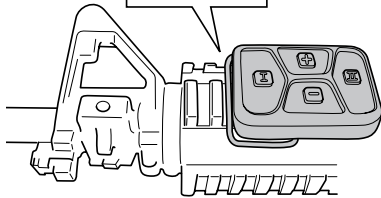
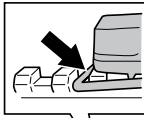

4

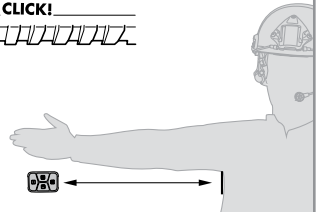
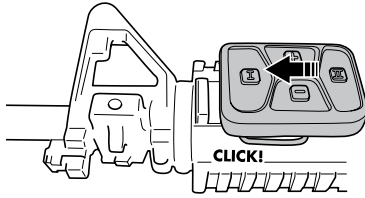

1

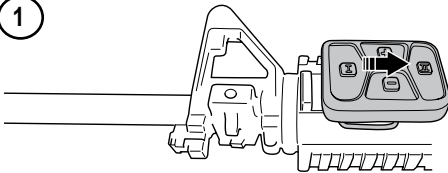

2

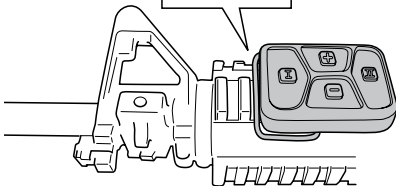
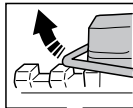

3

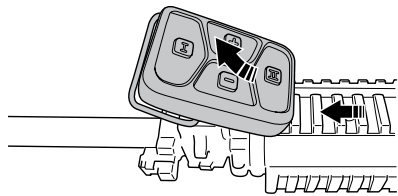

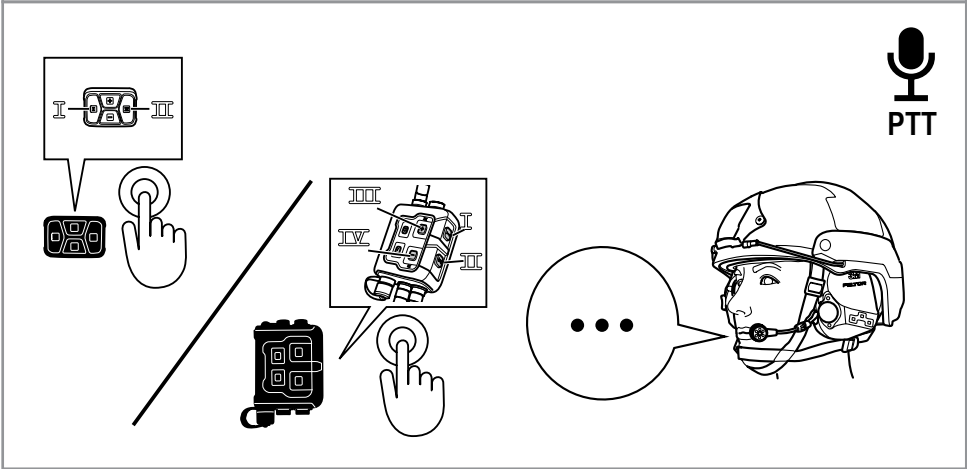
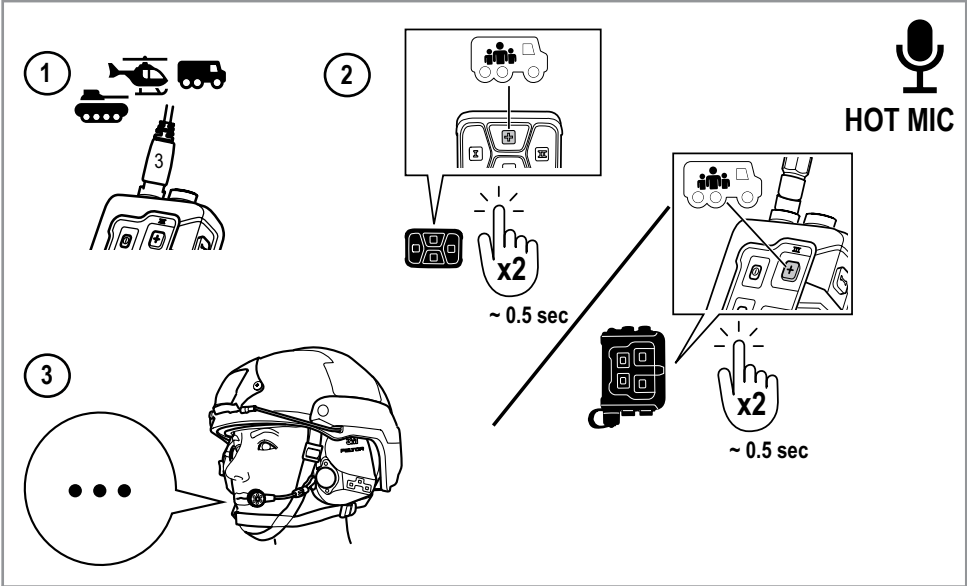



1

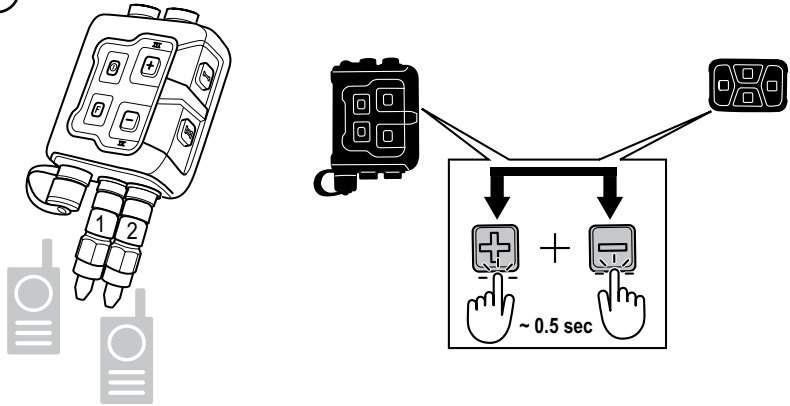

2

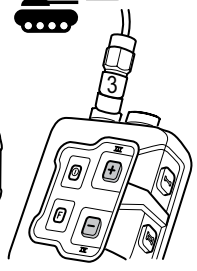
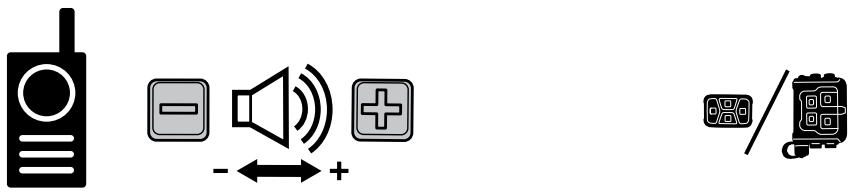

Tactical Modular Audio System



## Tactical Modular Audio System

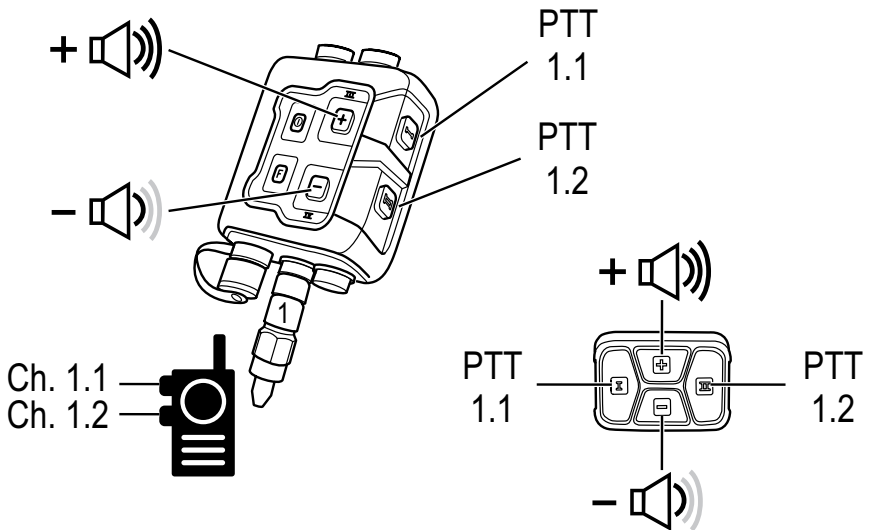
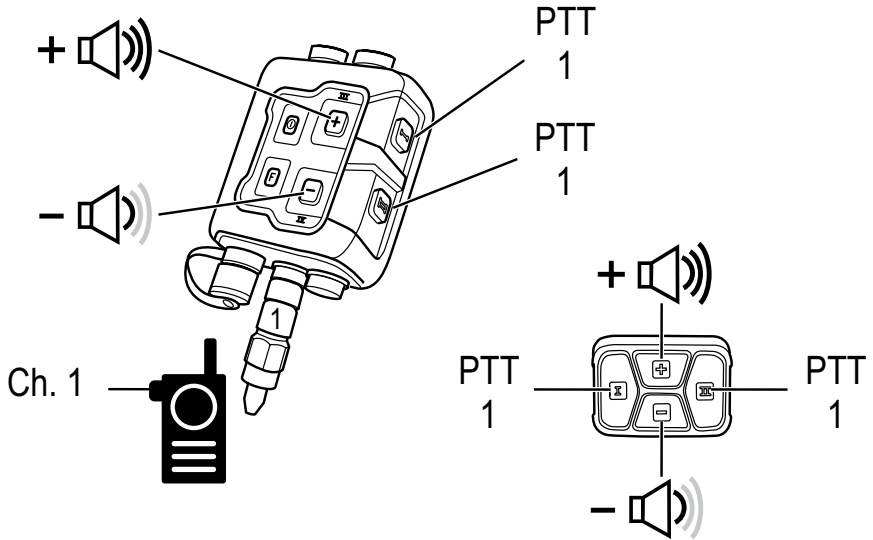



# Tactical Modular Audio System

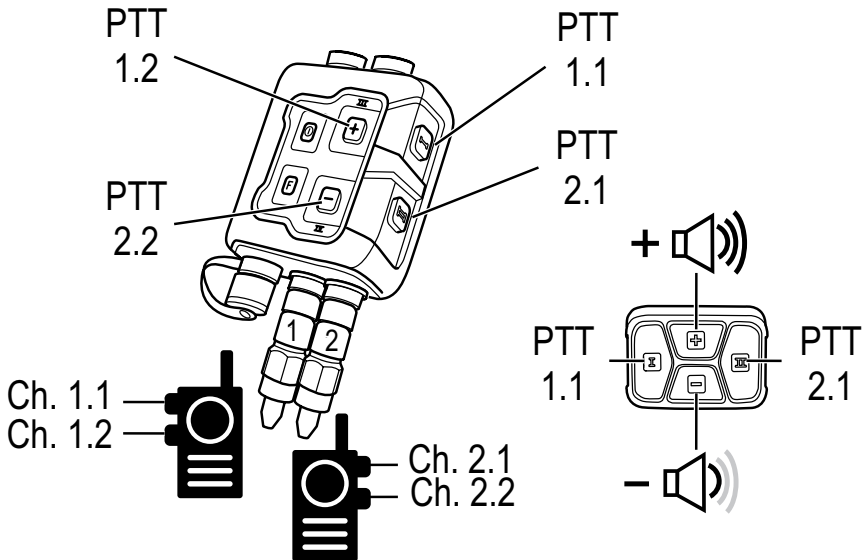
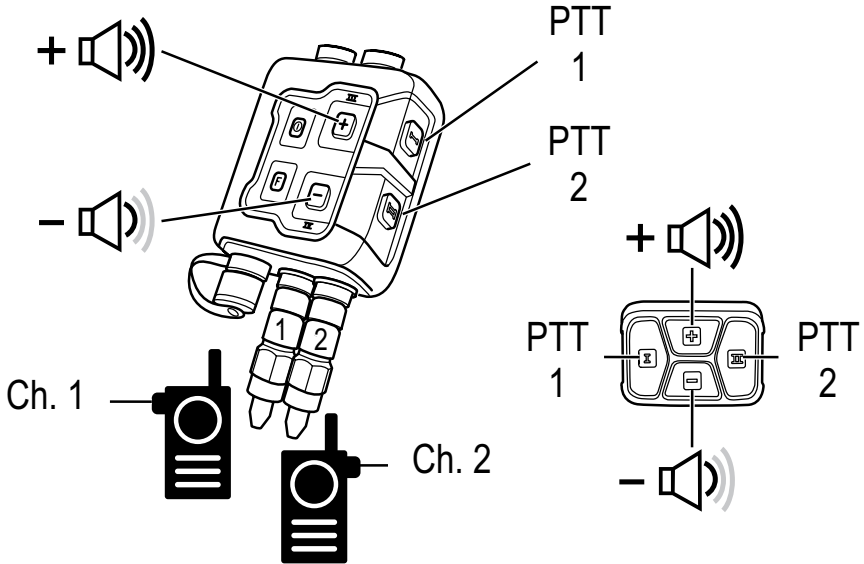





# Tactical Modular Audio System

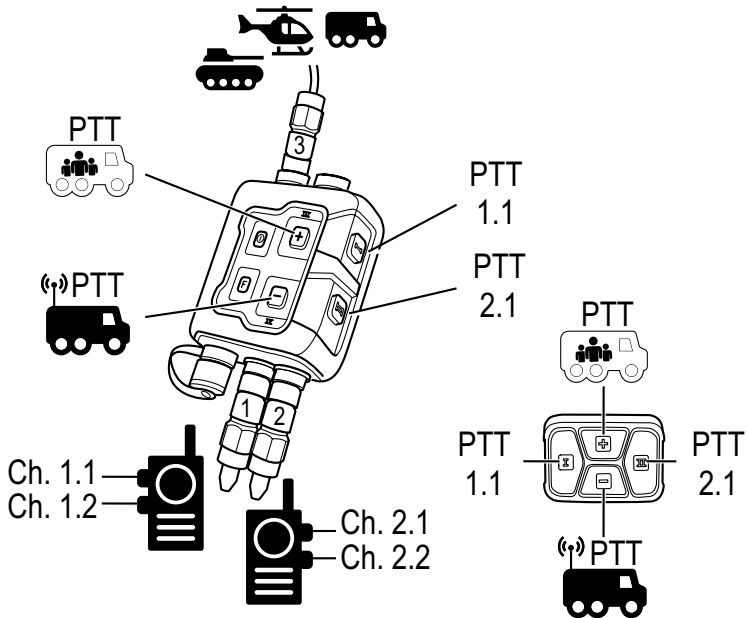
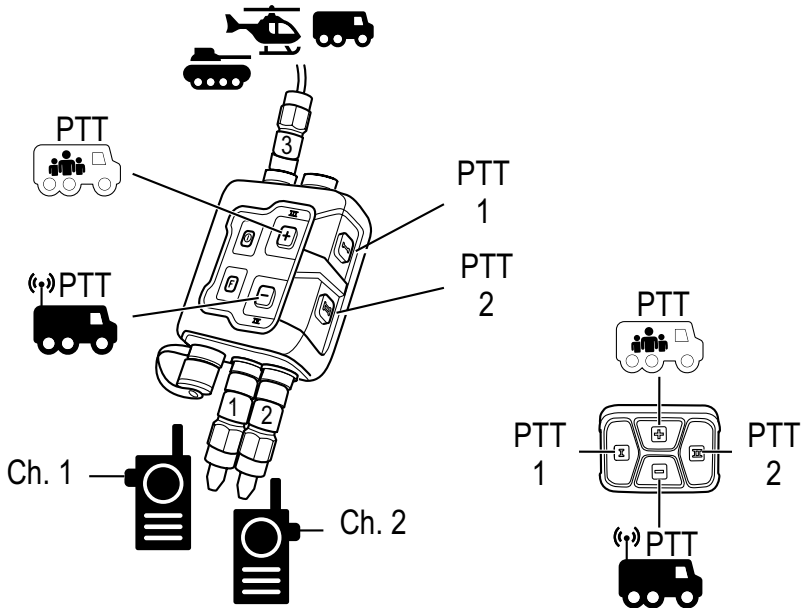



## **3M™ PELTOR™ Tactical Modular Audio System**

### **1. INTRODUCTION**

---

Congratulations and thank you for choosing 3M™ PELTOR™ protective communication solutions! Welcome to the next generation of protective communication.

#### **1.1. INTENDED USE**

The 3M™ PELTOR™ Tactical Modular Audio System (TMAS) is comprised of the System Control Unit (SCU-300), the Remote Control Unit (RCU-300), the ComTac™ VII headset and/or the Tactical Earplug (TEP-300). The SCU-300 connects all products in the system and controls various functions of the products. The SCU-300 can also be connected to external communication devices such as radios and intercom systems. Both the ComTac™ VII and the TEP-300 can be used separately or together as part of the Tactical Modular Audio System and both offer two-way communication capabilities. The ComTac™ VII headset also offers Natural Interaction Behavior (NIB) functionality, allowing headset-to-headset, near proximity communications in high noise without the use of an external communications device.

It is expected that all users read and understand the provided User Instructions as well as be familiar with the use of the relevant TMAS components: SCU-300, RCU-300, ComTac™ VII, and/or TEP-300.

## 2. SAFETY

### 2.1. IMPORTANT

Please read, understand, and follow all safety information in these instructions, and in the User Instructions for your relevant TMAS components: SCU-300, RCU-300, ComTac™ VII, and/or TEP-300, prior to use. Retain these instructions for future reference. For additional information or any questions, contact 3M Technical Services. Refer to contact information listed on the last page of this manual.

## 3. OVERVIEW

### 3.1. TEP-300

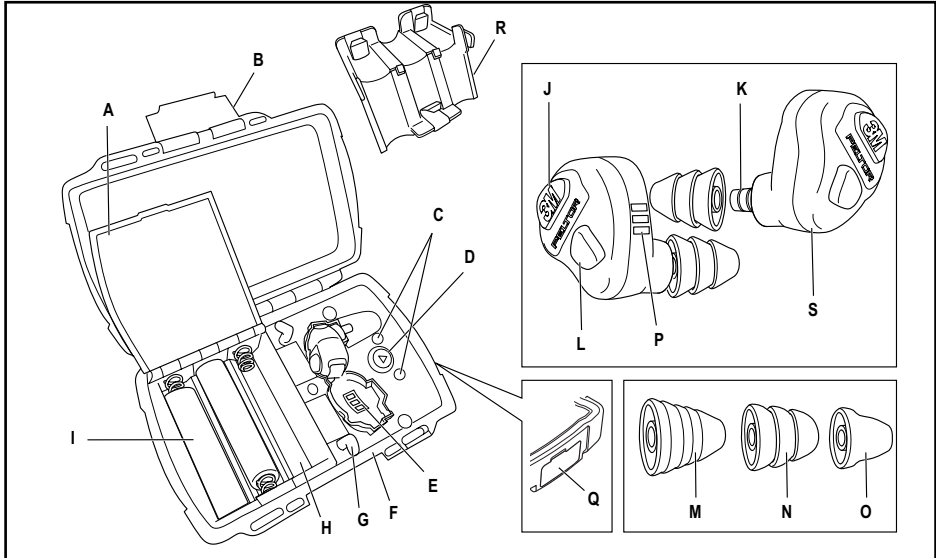

- A Battery lid
- B Latch
- C Indication LED
- D Test/Status button
- E Charging receptacle
- F Charging case
- G Retention cord storage posts
- H Battery compartment
- I AA battery
- J Power/Control Button
- K Eartip Stem
- L Windscreen/Microphone Cover
- M Eartip - Skull screws tips/Torque Communication tips
- N Eartip - Ultrafit tips
- O Eartip - CCC tip
- P Eartip charging contacts
- Q USB-C charging port
- R AAA battery adapter
- S Earpiece

### 3.2. COMTAC™ VII

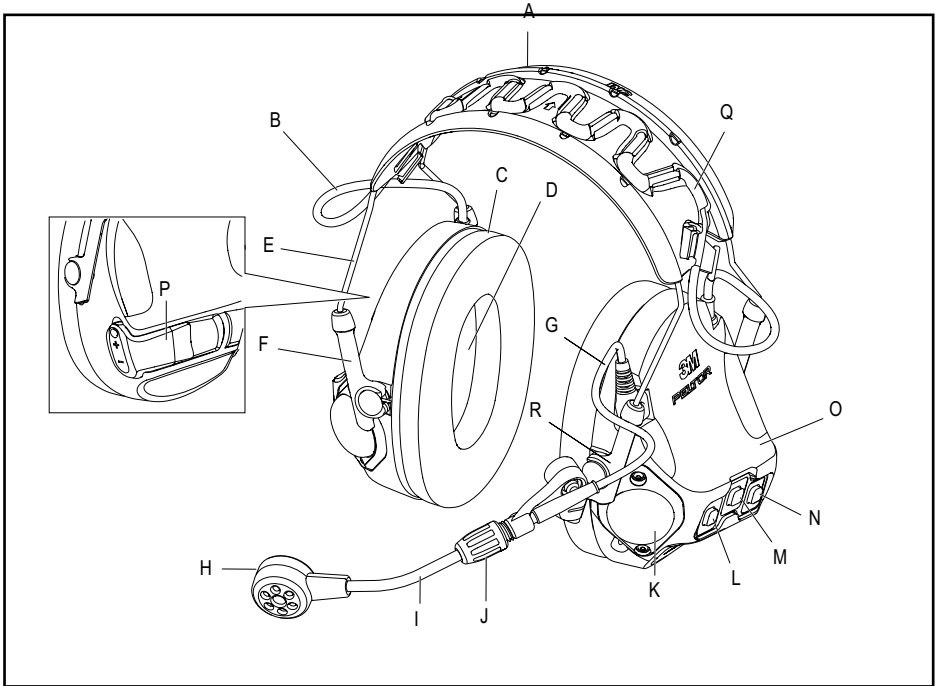

- A Headband
- B Headband cable
- C Ear cushion
- D Foam liner
- E Headband wire
- F Guide
- G Communication microphone connector
- H Communication microphone
- I Communication microphone arm
- J Adjustable screw
- K Environmental/Ambient microphone
- L + button
- M NIB button
- N - button
- O Earcup
- P Battery compartment cover
- Q Guide for the headband cable
- R Communication microphone guide

3.3. SCU-300

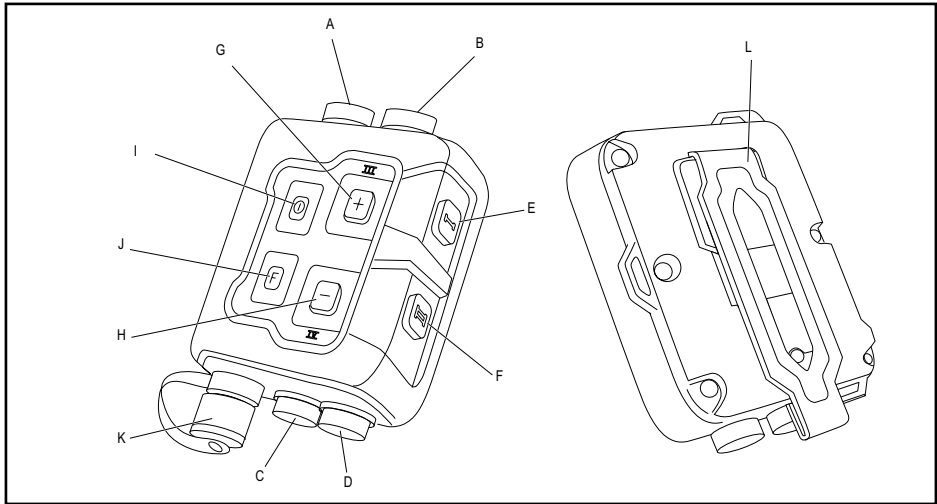

- A Intercom socket
- B Headset socket
- C Radio 1 socket
- D Radio 2 socket
- E PTT I button
- F PTT II button

- G + button
- H - button
- I On/Off/Menu button
- J Function button
- K Battery cap
- L Metal clip

3.4. RCU-300

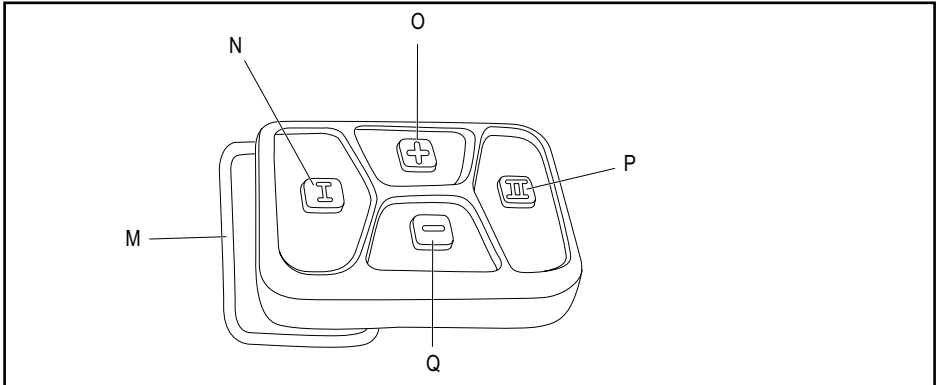

- M Locking bracket (Stainless steel)
- N PTT I button

- O + button
- P PTT II button
- Q - button

## 4. TO POWER ON THE 3M™ PELTOR™ TACTICAL MODULAR AUDIO SYSTEM

### 4.1. OPERATING TEMPERATURE

-20°C/-4°F to 50°C/122°F.

### 4.2. START SEQUENCE

To operate the 3M™ PELTOR™ Tactical Modular Audio System, make sure to fit and power on the system components in the correct sequence. For more detailed instructions, refer to the User Instructions for the system components.

1. TEP-300, refer to "4.5. To power on the TEP-300".
2. ComTac™ VII, refer to "4.6. To power on the ComTac™ VII".
3. SCU-300, refer to "4.7. To power on the SCU-300".
4. RCU-300, refer to "4.8. To power on the RCU-300".

### 4.3. TO FIT THE SCU-300

1. Slide the metal clip onto the rails on the back of the SCU-300.

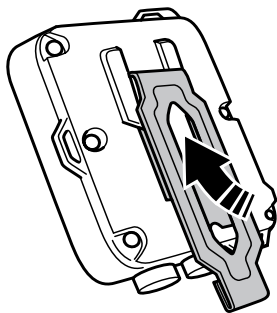

2. Attach the SCU-300 to your protective vest according to the illustration.

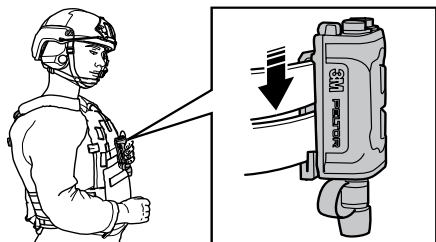

**IMPORTANT!** Make sure that the SCU-300 is placed in upright position and as high as possible within the chest area.

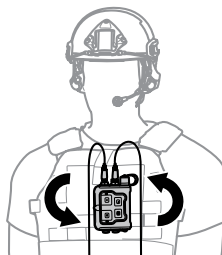
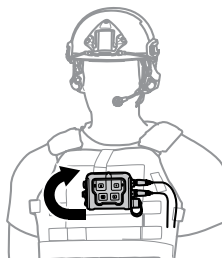
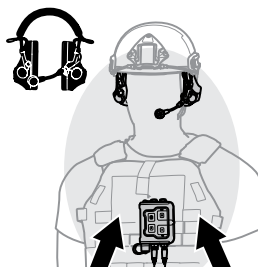

#### 4.4. TO FIT THE RCU-300

1. Pull and lift the locking bracket of the RCU-300 outwards and upwards.

**IMPORTANT!** Make sure that the RCU-300 is placed within arm-length from the SCU-300.

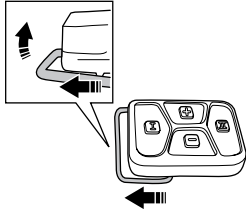

2. Slide the RCU-300 onto the rail system.

**IMPORTANT!** Make sure that the locking bracket is facing the barrel.

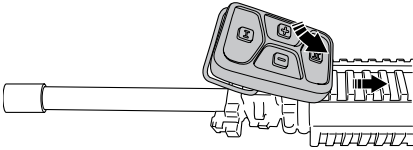

3. Fold down the locking bracket of the RCU-300.

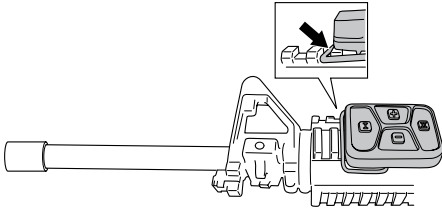

4. Pull the RCU-300 towards the barrel to lock it into place.

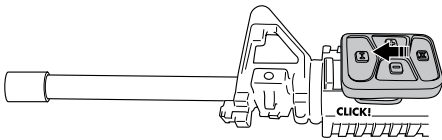

#### 4.5. TO POWER ON THE TEP-300

**Note:** The TEP-300 power on automatically when removed from the case. This section applies if TEP-300 has not been stored in the case or has been powered off for eartip selection and fitting.

1. Press and hold the power/control button for a minimum of 3 seconds.

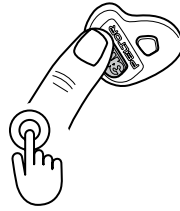

ON ~ 3 sec  
OFF ~ 3 sec



Beep Beep



Beeeeep Beeeeep Beeeeep

**Note:** The earplugs will indicate that the product is on/off with a "triple tone" sequence. A longer tone that repeats three times indicates that the product is not connected to the SCU-300 yet or that it has lost connection. Refer to "5.3. To connect the TEP-300 to the SCU-300".

**Note:** Beeping sounds only occur if the headset has previously been paired with the SCU-300.

2. Repeat this process for the other earplug.

**Note:** If a "squealing" tone is heard emitting from the TEP-300, it is an indication that the earplug is not properly inserted and that an airtight seal has not been obtained. The product should not be used in hazardous noise if a proper eartip seal is not achieved.

#### 4.6. TO POWER ON THE COMTAC™ VII

Make sure the ComTac™ VII is correctly fitted. Refer to fit the product in the User Instructions for ComTac™ VII.

1. Press and hold the + button for a minimum of 3 seconds.
2. Make sure the ComTac™ VII is correctly fitted. Refer to "To fit the product" in the User Instructions for ComTac™ VII.

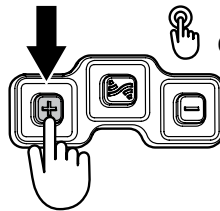

ON ~ 3 sec  
OFF ~ 3 sec

The headset will indicate power mode with appropriate audio message of "Power On" or "Power Off".

**Note:** A beeping sound indicates the headset is not connected to the SCU-300. Refer to section "5.4. To connect ComTac™ VII to the SCU-300".



## 4.7. TO POWER ON THE SCU-300

If the SCU-300 was previously connected to the TEP-300 or ComTac™ VII, the devices will connect automatically when within range of the SCU-300 and devices are powered on.

1. The user must first employ TEP-300 and/or the ComTac™ VII. Refer to the User Instructions of those products for start-up instructions.

**NOTE:** The SCU-300 must be positioned correctly during startup to correctly pair with each device. Refer to "4.3. To fit the SCU-300".

2. Press and hold the On/Off/Menu button on the SCU-300 for ~3 seconds.

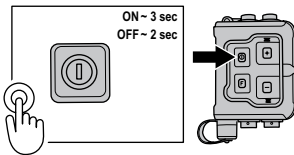

3. The TEP-300 and/or the ComTac™ VII will indicate pairing.
  - 2 short beeps, indicates a successful pairing to the SCU-300.
  - 3 long beeps, indicates the NFMI link is lost.



**Note:** Beeping sounds only occur if the headset has previously been paired with the SCU-300.

4. If pairing fails, check proper SCU-300 placement. If problem persists, press the On/Off/Menu button on the SCU-300 for ~10 seconds or until 2 short beeps are heard in TEP-300 and/or the ComTac™ VII.

## 4.8. TO POWER ON THE RCU-300

1. Short press the + button to power on the RCU-300.

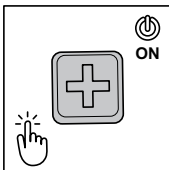

2. Press any button to wake up the RCU-300 if it has gone into sleep mode.

## 5. TO PAIR AND CONNECT THE SYSTEM

### 5.1. TO PAIR THE RCU-300 TO THE SCU-300

RCU-300 uses Bluetooth® Low Energy communication.

Bluetooth® Low Energy is a short-range wireless communication protocol. It is designed for long battery life. The range is ≈ 50 cm/20 in.

Pairing the RCU-300 to the SCU-300 requires the use of the TEP-300 or ComTac™ VII headset. Refer to those products' User Instructions for use information.

To receive auditory prompts when powering on the SCU-300, the user must first employ the ComTac™ VII headset or TEP-300 earplugs. If the SCU-300 was previously connected to the TEP-300 or ComTac™ VII, the devices will connect automatically when within range of the SCU-300 and devices are powered on.

1. Power on the TEP-300 and/or ComTac™ VII. Refer to "4.5. To power on the TEP-300" and/or "4.6. To power on the ComTac™ VII".

**NOTE:** Make sure the TEP-300 and/or ComTac™ VII are correctly fitted. Refer to the User Instructions for those products.

2. Power on SCU-300. Refer to "4.7. To power on the SCU-300".
3. Power on the RCU-300. Refer to "4.8. To power on the RCU-300".
4. Short press the power button on the SCU-300 to access the menu.

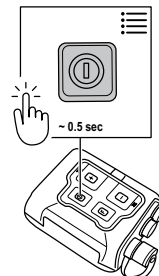

5. Short press the - button to move forward in the menu system until the audio message indicates the "Advanced settings" sub menu.
6. Select "Advanced settings" with the + button.

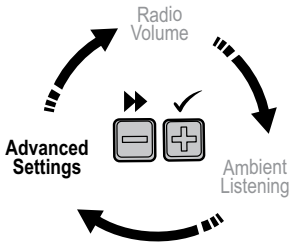

7. Short press the - button to move forward in the sub-menu system until the audio message indicates "Primary RCU pairing".
8. Select "Primary RCU pairing" with the + button.
9. Press and hold the PTT II button and - button on the same time on the RCU-300.

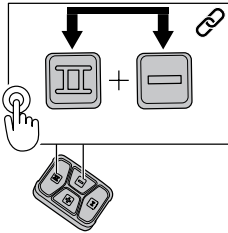

10. While pressing the buttons on the RCU-300, hold the RCU-300 against the SCU-300 to pair.

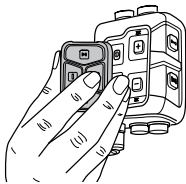

11. An audio message will indicate Primary/Secondary RCU connected.

**Note:** Select Secondary RCU pairing and repeat the steps to pair a second RCU-300.

**Note:** To reset the RCU-300, press and hold the + and - button on the RCU-300 for 10 seconds.

## 5.2. TO PAIR THE SCU-300 WITH A BLUETOOTH® DEVICE\*\*

Bluetooth® is a wireless technology standard for exchanging data between fixed and mobile devices over short distances.

1. Enable Bluetooth® on your mobile device. Refer to the User Instructions for the mobile device.
2. Press and hold the Function button on the SCU-300.

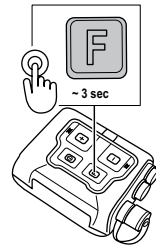

**Note:** When Bluetooth® is enabled on your mobile device, it should automatically begin a search for Bluetooth® devices with which to connect. When the search has completed, a list of devices you can connect to will appear on the screen. Select "SCU" on your mobile device.

## 5.3. TO CONNECT THE TEP-300 TO THE SCU-300

The TEP-300 connects to the SCU-300 using Near Field Magnetic Induction (NFM). NFM is a short range wireless physical layer that communicates by coupling a tight, low-power, non-propagating magnetic field between devices. The range is ≈ 50 cm/20 in. NFM systems are designed to contain transmission energy within the localized magnetic field and the energy does not radiate into free space.

If previously connected with the SCU-300, the TEP-300 will connect automatically when within range of the SCU-300. The earplugs indicate that the product is connected to the SCU-300 with 2 short beeps. For more information refer to User Instructions for 3M™ PELTOR™ Tactical Modular Audio System.

**Note:** If not previously connected to the SCU-300, the TEP-300 must be paired manually. Refer to "5.3.1. To connect the TEP-300 to the SCU-300 for the first time".

1. Fit the earplugs.
 

**NOTE:** Make sure that the TEP-300 is correctly fitted. Refer to the User Instructions for TEP-300.
2. Power on the TEP-300. Refer to "4.5. To power on the TEP-300".
3. Press the On/Off/Menu button on the SCU-300 for ~2 seconds.

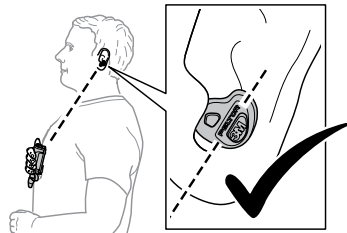

**Note:** Beeping sounds only occur if the TEP-300 has previously been paired with the SCU-300.

The TEP-300 will indicate pairing.

- 2 short beeps, indicates a successful pairing to the SCU-300.
- 3 long beeps, indicates the NFM link is lost.

**Note:** If pairing fails, check proper SCU-300 placement. If problem persists, press the On/Off/Menu button on the SCU-300 for ~10 seconds or until 2 short beeps are heard in TEP-300. For more information, refer to “12. Troubleshooting”.

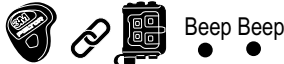

Beep Beep

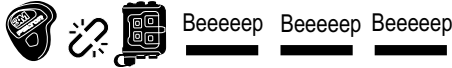

Beeeeep Beeeeep Beeeeep

### 5.3.1. TO CONNECT THE TEP-300 TO THE SCU-300 FOR THE FIRST TIME

1. Fit the earplugs.

**NOTE:** Make sure that the TEP-300 is correctly fitted. Refer to the User Instructions for the TEP-300.

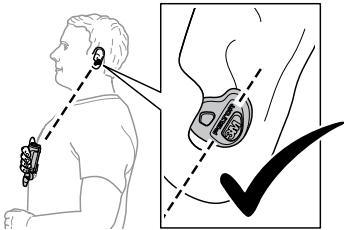

2. Fit the SCU-300. Refer to “4.3. To fit the SCU-300”.
3. Power on the earplugs. Refer to “4.5. To power on the TEP-300”.
4. Press and hold the On/Off/Menu button on the SCU-300 for a minimum of ~10 seconds.

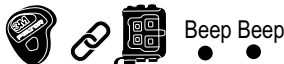
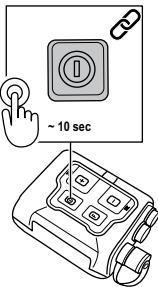

Beep Beep

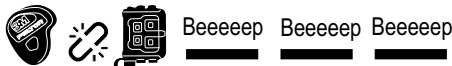

Beeeeep Beeeeep Beeeeep

The TEP-300 will indicate pairing.

- 2 short beeps, indicates a successful pairing to the SCU-300
- 3 long beeps, indicates the NFMI link is lost. Press and hold the On/Off/Menu button for a minimum of 10 seconds to reconnect the hearing protection.

## 5.4. TO CONNECT COMTAC™ VII TO THE SCU-300

ComTac™ VII connects to the SCU-300 using Near Field Magnetic Induction (NFMI). NFMI is a short range wireless physical layer that communicates by coupling a tight, low-power, non-propagating magnetic field between devices. The range is ≈ 50 cm/20 in. NFMI systems are designed to contain transmission energy within the localized magnetic field and the energy does not radiate into free space.

If previously connected with the SCU-300, the ComTac™ VII will connect automatically when within range of the SCU-300. The headset indicates that the product is connected to the SCU-300 with 2 short beeps. For more information refer to User Instructions for 3M™ PELTOR™ Tactical Modular Audio System.

**Note:** If not previously connected to the SCU-300, the ComTac™ VII must be paired manually. Refer to “5.4.1. To connect ComTac™ VII to the SCU-300 for the first time”.

1. Power on the ComTac™ VII. Refer to “4.6. To power on the ComTac™ VII”.

**NOTE:** Make sure the ComTac™ VII is correctly fitted. Refer to the User Instructions for ComTac™ VII.

2. Press the On/Off/Menu button on the SCU-300 for ~2 seconds.

The ComTac™ VII will indicate the pairing.

- 2 short beeps, indicates a successful pairing to the SCU-300.
- 3 long beeps, indicates a failed pairing to the SCU-300.



Beep Beep

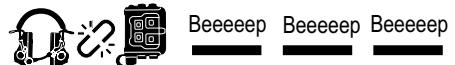

Beeeeep Beeeeep Beeeeep

**Note:** Beeping sounds only occur if the headset has previously been paired with the SCU-300.

If the pairing fails, press the On/Off/Menu button on the SCU-300 for ~10 seconds. Or until 2 short beeps are heard in the ComTac™ VII. For more information, refer to “12. Troubleshooting”.

### 5.4.1. TO CONNECT COMTAC™ VII TO THE SCU-300 FOR THE FIRST TIME

1. Fit the ComTac™ VII.

**NOTE:** Make sure the ComTac™ VII is correctly fitted. Refer to the User Instructions for ComTac™ VII.

2. Fit the SCU-300. Refer to “4.3. To fit the SCU-300”.
3. Power on the ComTac™ VII. Refer to “4.6. To power on the ComTac™ VII”.
4. Press and hold the On/Off/Menu button on the SCU-300 for a minimum of ~10 seconds.

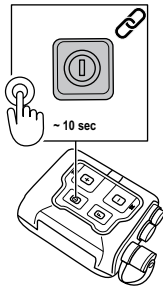

The ComTac™ VII will indicate pairing.

- 2 short beeps, indicates a successful pairing to the SCU-300.
- 3 long beeps, indicates the NFMI link is lost. Press and hold the On/Off/Menu button for a minimum of 10 seconds to reconnect the hearing protection.

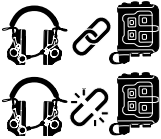

Beep Beep

Beeeeeep Beeeeeep Beeeeeep

## 5.5. TO CONNECT THE EXTERNAL RADIO TO THE SCU-300

1. Power on the radio.
2. Ensure radio volume is set to a comfortable level.
3. Connect the cable to the radio. For instructions on how to connect the radio, refer to the radio manual.
4. Align the markings on the cable to the markings on the SCU-300.

**IMPORTANT!** Make sure to select the correct socket on the SCU-300 for the radio.

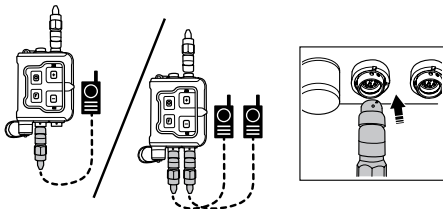

5. Connect the cable with the SCU-300 and turn the cable clockwise to lock into place.

## 5.6. TO CONNECT AN EXTERNAL INTERCOM TO THE SCU-300

1. Connect the cable to the intercom system. For instructions on how to connect the intercom system, refer to the intercom manual.

2. Align the markings on the cable to the markings on the SCU.

**IMPORTANT!** Make sure to select the correct socket on the SCU-300 for the intercom system.

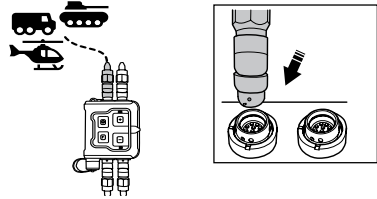

3. Connect the cable with the SCU-300 and turn the cable clockwise to lock into place.

## 6. VOLUME

### 6.1. TO ADJUST THE AMBIENT (ENVIRONMENTAL) VOLUME

The environmental microphones help the user to maintain auditory situational awareness and communicate naturally in lower noise environments.

- The + button and - buttons on the SCU-300 and RCU-300 adjust the Ambient (Environmental) Volume on the TEP-300 and/or ComTac™ VII.

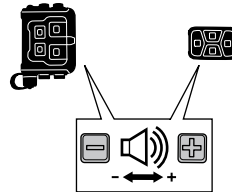

- Press the + button to increase the Ambient (Environmental) Volume.
- Press the - button to decrease the Ambient (Environmental) Volume. To mute the product, press the - button on the SCU-300/RCU-300 until an audio message indicates that product is in silent mode "Ambient listening off".

**Note:** Volume control defaults to headset Ambient (Environmental) Volume. To change the volume level on connected devices, refer to section "6.2. To Adjust the radio/intercom volume using the SCU-300 or RCU-300".

**Note:** When connected to an intercom system, this method of changing ambient (environmental) headset volume will not be available. In that case, it is necessary to enter the menu and select Ambient Listening Volume to change the volume of those devices.

## 6.2. TO ADJUST THE RADIO/INTERCOM VOLUME USING THE SCU-300 OR RCU-300

1. Short press both + and - buttons simultaneously.

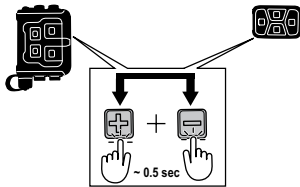

2. Press either the + or - button within 2 seconds to change the volume level on connected devices. After 2 seconds the volume control will return to set the environmental listening.

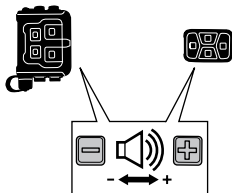

**NOTE:** When connected to an intercom system, this method of changing the volume of connected radios/intercom systems will not be available. In that case, it is necessary to enter the menu and select Radio Volume to change the volume of those devices.

## 6.3. TO ADJUST THE RADIO VOLUME ON THE RADIO

Refer to technical documentation of the radio.

## 7. OPERATION OF FUNCTIONS

### 7.1. TO USE THE NIB FUNCTION

NIB offers electronic, headset-to-headset communication with a transmission range of  $\approx 10$  m/11 yd from the speaker. There is no limit regarding how many people within that transmission range that can receive the transmission.

Up to 4 users within  $\approx 150$  m/165 yd can transmit simultaneously using 1 of 4 open slots/channels. Once all 4 channels are active, no one else in the group can transmit until a channel becomes available. If a fifth person tries to transmit, a beeping sound will indicate that the message was not transmitted. This  $\approx 150$  m/165 yd range is in an open field (line in sight) and may be reduced by physical structures.

**Note:** Optimal signal for communication is reached within a radius of  $\approx 5$  m/5.5 yd. NIB volume within the  $\approx 5$  m/5.5 yd is maximized. NIB volume will decrease in the  $\approx 5$ -10 m/5.5-11 yd. range as the listener gets further from the speaker.

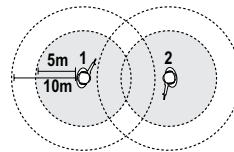

1. Double tap on the NIB button to access the NIB menu.

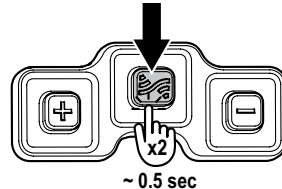

There are 3 different NIB modes.

- NIB VOX
- NIB PTT
- NIB OFF

**Note:** The NIB is constantly active in both NIB PTT and NIB VOX modes. To silence all NIB activity completely, switch headset to NIB OFF mode.

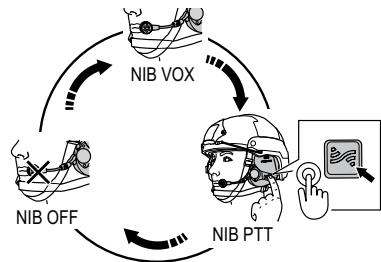

### 7.1.1. NIB VOX

NIB VOX mode allows for hands free communications using NIB when noise levels rise to approximately 80 dB Sound Pressure Level (SPL). The NIB Control Button can be used as a PTT for NIB communications in noise levels less than 80 dB SPL.

For environments with irregular noise levels the PTT button can also be used to manually control the voice transmit.

**Note:** NIB is equipped with a busy channel signal (three beeps), to notify the user that the headset did not transmit an outgoing NIB transmission. In NIB VOX mode, loud sounds, such as weapons fire, or wind striking the communications mic at high speed, can activate NIB transmission. If more than four connected headsets are in NIB VOX mode and operating in one of the conditions listed, the headset misinterprets the loud sound to be that of a user attempting to transmit. When this happens, the user will hear a repeating busy channel signal in their headset. If this occurs, the user can place the headset in NIB PTT or NIB OFF mode to reduce the busy channel signal. Additionally, a user can turn off warning signals in the headset menu.

### 7.1.2. NIB PTT

1. Press and hold the NIB button when speaking into the microphone.

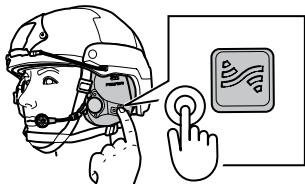

2. Release the NIB button when the message is complete.

**NOTE:** Make sure that the NIB button is not pressed when you are not speaking into the microphone.

### 7.1.3. NIB OFF

The NIB function is off.

## 7.2. HOT MIC FUNCTION

The Hot Mic function enables hands free transmitting of messages when the SCU-300 is connected to an external intercom system.

### 7.2.1. TO ACTIVATE THE HOT MIC FUNCTION

1. Make sure that a external intercom system is connected to the SCU-300.

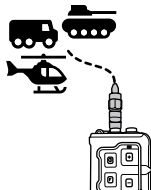

2. Double tap on the + button on the SCU-300 or the + button on the RCU-300 to activate Hot Mic.

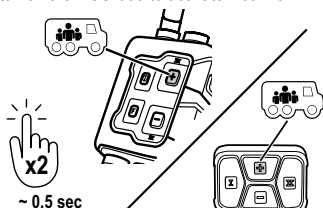

**Note:** To deactivate the Hot Mic function, double press the + button on the SCU-300 or the + button on the RCU-300.

## 7.3. TO USE THE BLUETOOTH® FUNCTION\*\*

### 7.3.1. MAKING OR ANSWERING PHONE CALLS WITH BLUETOOTH®\*\*

When the SCU-300 is connected with Bluetooth® to a mobile device, you can use the Function button on the SCU-300 to answer, hang up or reject a call from your mobile device. You can also use the PTT II button on the RCU-300.

To be able to operate the Function button on the RCU-300, change the settings on the SCU-300. Refer to "7.3.2. To transfer the function button to the RCU-300".

**Note:** Before making or taking a call, make sure that the SCU-300 is connected to a mobile device.

#### To answer a call

- Press the Function button on the SCU-300 or PTT II button on the RCU-300 to answer a call from your mobile device. A short beep will be heard in the hearing protection before you hear the incoming call.

#### To hang up a call

- Press the Function button on the SCU-300 or PTT II button on the RCU-300 to hang up a call from your mobile device. A short beep will be heard in the hearing protection to indicate that the call has been ended.

#### To reject a call

- Press and hold the Function button on the SCU-300 or PTT II button on the RCU-300 to reject the call. A short beep will be heard in the hearing protection to indicate that the call has been rejected.

#### To make a call

- Dial the phone number from your connected mobile device. The call will automatically transfer to the hearing protection.

#### To make a call using the voice guided function

1. Press and hold the Function button on the SCU-300 or the PTT II button on the RCU-300 for 3 seconds to activate voice guided function. You will hear 2 quick beeps to indicate that the voice guided function is active and is waiting for your instructions.
2. Say "call" followed by a name from your contact list or "dial" followed by a number.

### 7.3.2. TO TRANSFER THE FUNCTION BUTTON TO THE RCU-300

To add the Function Button capability to the RCU-300, change the settings on the SCU-300.

1. Short press the power button on the SCU-300 to access the menu.

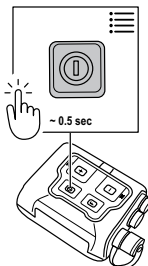

2. Press the - button to move forward in the menu system until the audio message indicates the sub menu Advanced settings.

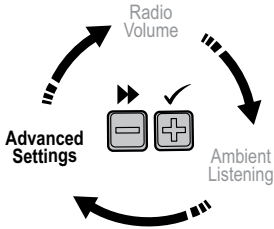

4. Press the + button to confirm and to access Advanced settings.
5. Press the - button to move forward in the menu system until the audio message indicates the sub menu Bluetooth® Functions button to RCU.
6. Press the + button to confirm.

**Note:** The PTT II button on the RCU-300 now has the same function as the F button on the SCU-300.

#### 7.4. DUAL PROTECTION AND EARPLUG MODE

The Tactical Modular Audio System (TMAS) is designed to allow dual hearing protection for high noise exposures. The TEP-300 or a non-electronic (passive) hearing protector can be worn under the ComTac™ VII to achieve dual hearing protection. When a non-electronic (passive) hearing protection device is used, it may be necessary to place the ComTac™ VII in Earplug Mode to maintain environmental auditory awareness and communications.

**NOTE:** The user must achieve an adequate hearing protector fit for both in-ear and over-ear hearing protectors to receive dual protection.

##### 7.4.1. DUAL PROTECTION WITH TEP-300

1. Insert and power-on the TEP-300. Refer to TEP-300 User Instructions.
2. Place the ComTac™ VII over the ears and power-on. Refer to ComTac™ VII User Instructions.
3. Power on the SCU-300. Refer to SCU-300 and TMAS User Instructions.
4. The ComTac™ VII and SCU-300 will automatically detect the TEP-300.

##### 7.4.2. DUAL PROTECTION WITH PASSIVE HEARING PROTECTOR AND EARPLUG MODE

Earplug Mode is useful when dual hearing protection is required, and the user prefers a passive hearing protection device, such as the 3M™ E-A-R™ Classic™ Earplug.

**WARNING!** DO NOT use the headset in Earplug Mode without properly fitted earplugs under the earmuffs, as the increase in audio volume may reach an unsafe level. Failure to wear properly fitted earplugs while operating in Earplug Mode may result in hearing loss or injury.

1. Properly fit the passive hearing protector.
2. Place the ComTac™ VII over the ears.

#### If the headset is powered off:

3. Press and hold the + button until an audio message says "Power on".
4. Keep pressing the + button until an audio message confirms "Earplug Mode".
5. Turn off ComTac™ VII to turn off the Earplug Mode.

#### If the headset is powered on:

6. Press and hold the + button until an audio message says "Power off".
7. Keep pressing the + button until an audio message confirms "Earplug Mode".
8. Turn off ComTac™ VII to turn off the Earplug Mode.

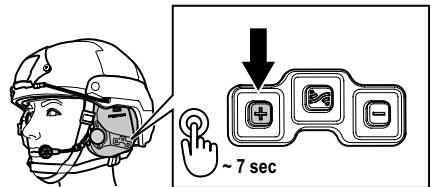

**NOTE:** The headset will first indicate that the product is off. Keep pressing the + button until an audio message indicates Earplug Mode.

## 8. TO NAVIGATE THE MENU SYSTEM

### 8.1. COMTAC™ VII

Press the + button and the - button at the same time to enter the menu system. The headset will indicate that the user has entered the menu with an audio message "Menu". For more information about the menu, refer to "9. Menu functions ComTac™ VII"

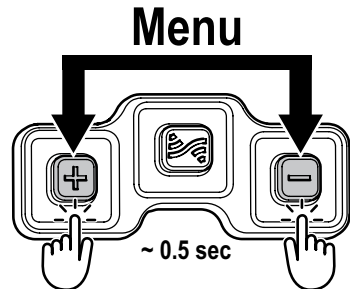

- Short press the - button to move forward in the menu system.
- Short press the + button to confirm or to access a sub-menu.

**Note:** Menu options and settings will be heard as an audio message in the headset.

To exit the menu, press the + and - buttons at the same time. The headset will automatically exit the menu if no button is pressed for 10 seconds.

## 9. MENU FUNCTIONS COMTAC™ VII

### 9.1. AMBIENT (ENVIRONMENTAL) LISTENING MODE

The ComTac™ VII can be set to different sound profiles depending on the acoustical environment and auditory needs. Regardless of the environmental listening setting, sounds above 82 dB are compressed to limit the output.

#### 9.1.1. AMBIENT LISTENING MODE - CLASSIC

This setting offers 4 preset volume levels and silent mode.

#### 9.1.2. AMBIENT LISTENING MODE - ADVANCED

This setting offers Mission Audio Profiles, designed to maximize environmental listening in the following situations.

- Silent mode - Optimized for communicating via NIB or radio in high levels of noise. Ambient listening mode is set to OFF.
- Comfort - Optimized for long periods in high levels of noise such as aircraft/vehicle transport.
- Conversation - Optimized for face-to-face communications.
- Patrolling - Optimized for enhanced auditory awareness when moving by foot by reducing sounds such as footsteps and personal equipment noise.
- Observation - Optimized for enhanced auditory awareness when still and in quiet.

### 9.2. BATTERY

Set the type of battery used on the ComTac™ VII. Battery type is used for battery life estimations.

- Alkaline - Sets the battery mode to alkaline battery.
- Rechargeable - Sets the battery mode to rechargeable battery.

### 9.3. BALANCE

The balance setting adjusts the volume balance between the right and left ear. There are 7 level settings:

- Center
- Left 1
- Left 2
- Max left
- Max right
- Right 2
- Right 1

**Note:** Changing the balance from center to a specific earcup does not increase the maximum output to that earcup.

### 9.4. WARNING SIGNALS

Enables or disables the different audio messages/warning signals heard in the headset.

- ON - ON - Enables all warning signals.
- OFF - Disable all warning signals.

### 9.5. AUTOMATIC POWER OFF

The headset is equipped with an auto shut-off to save battery life if the user forgot to power off after use. This function can be turned off in the menu.

- ON - The ComTac™ VII automatically turns off after 4 hours of the last button push. Pressing a control button resets the 4-hour timer.
- OFF - The ComTac™ VII does not turn off automatically.

**Note:** The headset will not power off automatically after 4 hours when connected to the SCU-300.

### 9.6. NIB FREQUENCY

The NIB frequency must be set for the users location to meet regulatory compliance requirements.

- 915 MHz - Is used for communication in North America, Australia and New Zealand.
- 864 MHz - Is used for communication in Europe, South America, Asia and Africa.

**Note:** Make sure that you are using the approved frequency for the region you are operating in.

### 9.7. FACTORY RESET

Resets the ComTac™ VII to the original settings.

### 9.8. TO NAVIGATE THE MENU SYSTEM – SCU-300

For more information about the menu system, refer to “10. Menu functions SCU-300”.

1. Short press the On/Off/Menu button to enter the menu system.

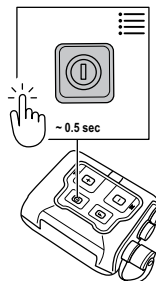

2. Short press the - button to move forward in the menu system.
3. Short press the + button to change the current menu setting.

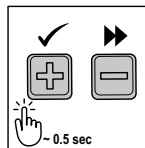

**Note:** The menu step will be heard as an audio message in the headset.



## 10. MENU FUNCTIONS SCU-300

---

### 10.1. RADIO VOLUME

Adjusts the volume of connected external communication devices and intercoms systems. Select one of the 5 preset volume levels.

### 10.2. AMBIENT (ENVIRONMENTAL) LISTENING VOLUME

Adjusts the Ambient (Environmental) Volume on connected headsets. Select one of the preset volume levels.

### 10.3. PRIMARY MICROPHONE

Select the primary speech communications microphone.

**Note:** This menu level is only available when both TEP-300 and ComTac™ VII is connected to the SCU-300.

### 10.4. ADVANCED SETTINGS

#### 10.4.1. BATTERY STATUS

Performs a battery status check on SCU-300, RCU, TEP-300 and/or ComTac™ VII.

#### 10.4.2. RADIO SILENCE

Silences NIB, NFMI and Bluetooth® signals emitted from the TMAS.

**NOTE:** Depending on the connected external communication device, this setting MAY NOT silence detectable signals emitting from those devices. Please refer to radio user manuals regarding radio silence.

#### 10.4.3. VOICE GUIDE VOLUME

Set the volume on the automatic audio messages. Select between high or low based on the surrounding noise.

#### 10.4.4. NFMI PAIRING

Pairs products to the SCU-300.

#### 10.4.5. TRAINING MODE

Training mode is a test mode. The training mode allows the user to test which placement of the SCU-300 is the best for the current situation.

#### 10.4.6. SCU PLACEMENT

Set where you want to place the SCU-300. Select between chest position (recommended) or waist position.

#### 10.4.7. AUTO POWER OFF

The SCU-300 will automatically turn off after 2 h if the SCU-300 is not active during this time.

**Note:** The product will not turn off automatically if TEP-300 or ComTac™ VII is connected and active.

**Note:** Press any button to delay auto power off.

#### 10.4.8. WARNING SIGNALS

Enables or disables the different audio messages/warning signals heard in the headset.

- ON - Enables all warning signals.
- OFF - Disable all warning signals.

#### 10.4.9. RCU PRIMARY PAIRING

Pair the primary RCU-300 with the SCU-300.

#### 10.4.10. RCU SECONDARY PAIRING

Pair the secondary RCU-300 with the SCU-300.

**Note:** This menu level is only available when a primary RCU-300 is already connected to the SCU-300.

#### 10.4.11. BLUETOOTH® PAIRING\*\*

Pair the selected Bluetooth® unit with the SCU-300.

#### 10.4.12. BLUETOOTH® FUNCTION BUTTON\*\*

Transfer the functions of the F button on the SCU-300 to the PTT II button on the RCU-300. Refer to "7.3.2. To transfer the function button to the RCU-300".

#### 10.4.13. PRIMARY MICROPHONE

Select the primary speech communications microphone for TEP-300 or ComTac™ VII if not paired.

#### 10.4.14. BATTERY TYPE

Set the type of battery used on the SCU-300. Battery type is used for battery life estimations.

- Alkaline - Sets the battery mode to alkaline battery.
- Rechargeable - Sets the battery mode to rechargeable battery.

#### 10.4.15. RADIO AUDIO

Select 1 of the 3 preset sound profiles when you are using 2 radios and/or 2 channels. The sound profile sets how the sound from the radio and/or channel 1 and 2 will be heard.

**Note:** All other channels will be heard in both ears.

- Mix - The sound will be heard equally in both left and right ear.
- Surround - The sound will be perceived as it is coming from different directions. For example, 10 o'clock and 2 o'clock.
- Single - The sound will only be heard in one of the ears.

#### 10.4.16. SYSTEM POWER OFF

Turns off all connected TMAS components.

**Note:** For instructions on how to turn off radio/intercom, refer to the radio/intercom User Instruction.

#### 10.4.17. FACTORY RESET

Reset the SCU-300 to the original settings.

## 11. SCENARIOS

---

### 11.1. NIB SCENARIOS

#### 11.1.1. EXAMPLE 1

- Full range ≈ 5 m.

Everyone within the range of ≈ 5 m has full audio of the transmitted message.

- Transmission range ≈ 10 m.

Each person with a NIB system has a ≈ 10 m transmitting range.

- Faded audio range ≈ 10 m.

People outside the ≈ 5 m range have access to faded audio within the range of ≈ 10 m. People outside the ≈ 10 m range have no access to the transmitted message.

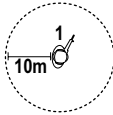

- Slot area approximately 150 m.

Each person with a NIB system has a slot area of approximately 150 m range. There are 4 open slots for transmitting within each slot area. This means that 4 people are able to transmit at the same time within the slot area.

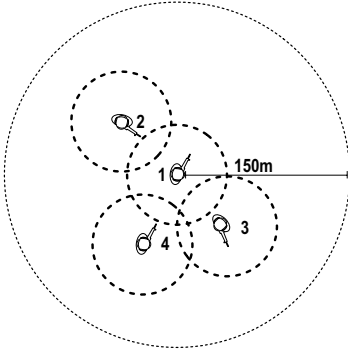

The fifth person transmitting will hear a beeping sound in the hearing protection, that indicates that the transmitting failed. No other in the group will hear this beeping sound. The fifth person will be able to transmit when 1 of the 4 people stops to transmit.

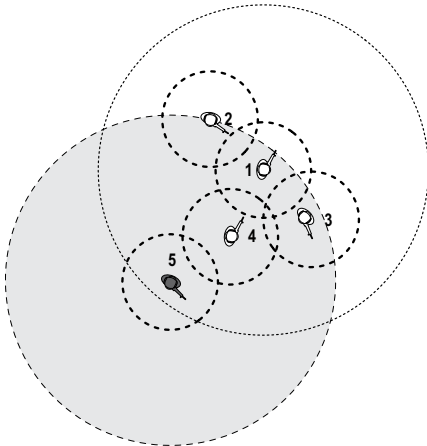

**11.1.2. EXAMPLE 2**

A group of 4 users are traveling together. The users are placed within the same NIB range (within 5-10 m/15-30 in.).

One of the users leaves the group to join another user. To reach this single user's NIB range they need to be within < 5-10 m from each other. The users automatically connect to

each others' NIB range.

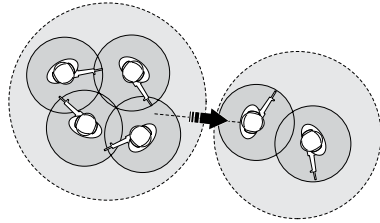

**11.2. RADIO SCENARIOS**

**11.2.1. SINGLE RADIO, ONE CHANNEL**

**Buttons on the SCU-300 for this scenario:**

- The PTT I and PTT II buttons are PTT for channel 1.
- The + and - buttons control the volume.

**Buttons on the RCU-300 for this scenario:**

- The PTT I and PTT II buttons are PTT for channel 1.

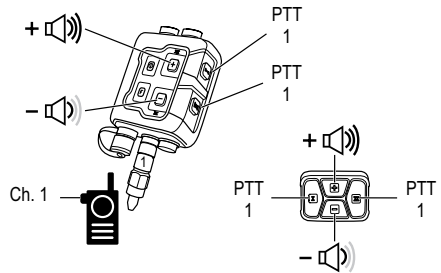

- The + and - buttons control the volume.

**11.2.2. SINGLE RADIO, MULTIPLE RADIO CHANNELS**

**Buttons on the SCU-300 for this scenario:**

- The PTT I button is PTT for channel 1.
- The PTT II button is PTT for channel 2.
- The + and - buttons control the volume.

**Buttons on the RCU-300 for this scenario:**

- The PTT I button is PTT for channel 1.
- The PTT II button is PTT for channel 2.

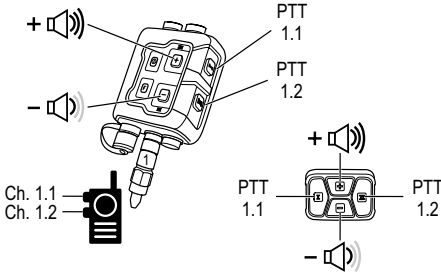

- The + and - buttons control the volume.

**11.2.3. TWO RADIOS, ONE CHANNEL EACH**

**Buttons on the SCU-300 for this scenario:**

- The PTT I button is PTT for Radio 1, channel 1.
- The PTT II button is PTT for Radio 2, channel 1.
- The + and - buttons control the volume.

**Buttons on the RCU-300 for this scenario:**

- The PTT I button is PTT for Radio 1, channel 1.
- The PTT II button is PTT for Radio 2, channel 1.
- The + and - buttons control the volume.

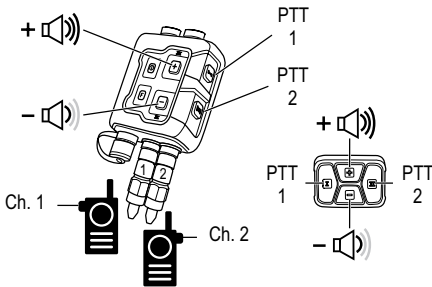

**11.2.4. MULTIPLE RADIOS, MULTIPLE CHANNELS**

**Buttons on the SCU-300 for this scenario:**

- The PTT I button is PTT for Radio 1, channel 1.
- The PTT II button is PTT for Radio 2, channel 1.
- The + button is PTT for radio 1, channel 2.

- The - button is PTT for radio 2, channel 2.

**Buttons on the RCU-300 for this scenario:**

- The PTT I button is PTT for Radio 1, channel 1.
- The PTT II button is PTT for Radio 2, channel 1.
- The + and - buttons control the volume.

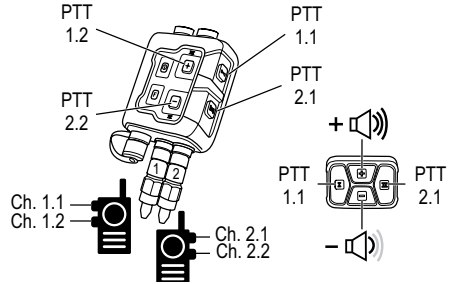

**11.3. INTERCOM SCENARIOS**

When connected to an intercom system, the button functions change on the SCU-300 and RCU-300.

**11.3.1. INTERCOM + TWO RADIOS, ONE CHANNEL EACH**

**Buttons on the SCU-300 for this scenario:**

- The PTT I button is PTT for Radio 1, channel 1.
- The PTT II button is PTT for Radio 2, channel 1.
- The + button is PTT for the intercom system.
- The - button is PTT for radio outside the vehicle.

**Buttons on the RCU-300 for this scenario:**

- The PTT I button is PTT for Radio 1, channel 1.
- The PTT II button is PTT for Radio 2, channel 1.
- The + button is PTT for the intercom system.
- The - button is PTT for radio outside the vehicle.

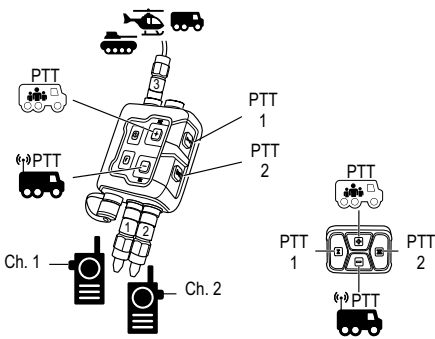

PTT symbol explanation:



PTT for internal intercom



PTT for radio in external vehicles

### 11.3.2. INTERCOM + TWO RADIOS, MULTIPLE RADIO CHANNELS

**Buttons on the SCU-300 for this scenario:**

- The PTT I button is PTT for Radio 1, channel 1.
- The PTT II button is PTT for Radio 2, channel 1.
- The + button is PTT for the intercom system.
- The - button is PTT for radio outside the vehicle.

Radio 1, channel 2 and Radio 2, channel 2 are listen only.

**Buttons on the RCU-300 for this scenario:**

- The PTT I button is PTT for Radio 1, channel 1.
- The PTT II button is PTT for Radio 2, channel 1.
- The + button is PTT for the intercom system.
- The - button is PTT for radio outside the vehicle.

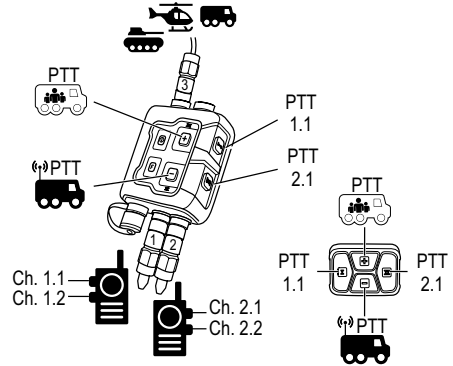

Radio 1, channel 2 and Radio 2, channel 2 are listen only.

## 12. TROUBLESHOOTING

### 12.1. TEP-300

Problem	Solution
The TEP-300 will not power on.	Place the earpieces in the charging case and perform a battery status check. Charge the earpieces if needed. Charge the TEP-300 if needed. Refer to the User Instructions for TEP-300.
	Ensure you are pressing the Power Button for a minimum of three seconds. Refer to "4.5. To power on the TEP-300".
The TEP-300 will not charge in the charging case.	Place the earpieces in the charging case and perform a battery status check. Replace the batteries if needed. Refer to the User Instructions for TEP-300.
	Make sure the batteries in the charging case are in the correct position. Refer to the User Instructions for TEP-300.
	Make sure the earpieces are placed correctly in the charging case. Refer to the User Instructions for TEP-300.
	If charging by USB, ensure the USB cord is fully connected to the charging case and that the charging source is adequate. Refer to the User Instructions for TEP-300.
	Make sure the charging contacts are free from dirt. Refer to the User Instructions for TEP-300.
	Incorrect charging temperature. Refer to the User Instructions for TEP-300.
Environmental sounds are difficult to hear.	Make sure the TEP-300 is powered on.
	Increase or decrease the volume setting to the level that maximizes hearing.
	Ensure the eartips are free of earwax.

### 12.2. COMTAC™ VII

Problem	Solution
The ComTac™ VII will not power on.	Replace the batteries if necessary. Refer to the manual for ComTac™ VII.
	Make sure that the batteries are placed correctly in the battery compartment of the ComTac™ VII. Refer to the User Instructions for ComTac™ VII.
	Make sure that the battery cover is fully closed.
Environmental sounds are difficult to hear.	Make sure the headset is powered on.
	Increase or decrease the volume setting to the level that maximizes hearing.
Will not send and/or receive radio communications.	For transmit issues, check the positioning of the communications microphone. Refer to the User Instructions for ComTac™ VII.
	Make sure that the radio is on. Ensure radio volume is turned up to an audible level.
	Make sure that all cables are connected securely and to the correct port on the SCU-300. Ensure the correct PTT button on the SCU-300 or RCU-300 is being pressed when transmitting.

Will not send and/or receive NIB communications.	Ensure you are pressing and holding the NIB button on the headset when transmitting. Refer to the manual for "3M™ PELTOR™ Tactical Modular Audio System".
	Make sure that the NIB button is pressed down during the complete message.
	Make sure NIB is not in the "NIB OFF" mode.
	Make sure to use the correct NIB frequency for your country. Refer to "9.6. NIB frequency".
	Ensure all headsets are set to the correct frequency.
	The listener may be too far from the person transmitting. Refer to the User Instructions for ComTac™ VII.
	Too many people transmitting within the range of approximately 150 m/165 yd. Refer to "11.1. NIB scenarios".

### 12.3. SCU-300

Problem	Solution
The SCU-300 will not power on.	Make sure the batteries are inserted correctly.
	Make sure there are fully charged batteries in the SCU-300.
The SCU-300 will not send and/or receive radio communications.	Check the cable connection to the radio and the SCU. A voice message will indicate Radio Connected.
	Ensure the SCU-300 is powered on.
	Check the radio volume.
	Make sure the radio is on.
The SCU-300 will not send and/or receive intercom communications.	Make sure that you are transmitting on the correct frequency.
	Make sure there are fully charged batteries in the SCU-300.
	Check the volume.
	Make sure the intercom is on.
The SCU-300 will not connect with or operate the ComTac™ VII and/or TEP-300.	Make sure the intercom is connected. A voice message will indicate "Intercom Connected".
	Ensure the SCU-300 is in Hot Mic mode or that you are pressing the specified SCU PTT button and the intercom PTT button if needed.
	Make sure there are fully charged batteries in the SCU-300.
	Restart the ComTac™ VII and/or TEP-300. For more information see product manuals for ComTac™ VII and/or TEP-300.
NFMI connection is unstable.	Restart the SCU-300.
	Make sure the SCU-300 is correctly fitted and aligned with ComTac™ VII. Refer to the manual for "3M™ PELTOR™ Tactical Modular Audio System".
	Make sure the products in the 3M™ PELTOR™ Tactical Modular Audio System has been started in the correct order. Refer to the manual for "3M™ PELTOR™ Tactical Modular Audio System".
	Press and hold the On/Off/Menu button on the SCU-300 for at least 10 seconds or until 2 short beeps, indicates a successful pairing. The headset will indicate "NFMI pairing on".
	Do a factory reset of the SCU-300. Refer to "10.4.19. Factory reset".
	If several users are placed close to each other, connect your headset to SCU-300 with the headset cable. Refer to "5.4. To connect ComTac™ VII to the SCU-300".
I get thrown out of the menu.	The user automatically exits the menu if no button is pressed for 10 seconds.

I cannot control the system with the RCU-300.	Make sure there are fully charged batteries in the SCU-300.
	Check the battery level of the RCU-300. Refer to "10.4.1. Battery status".
	Pair the SCU-300 to the RCU-300. Refer to "5.1. To pair the RCU-300 to the SCU-300".
	Make sure that you are using the correct RCU-300.
	Make sure the RCU-300 is not too far away from the SCU-300.
Do a factory reset of the RCU-300. Refer to "5.1. To pair the RCU-300 to the SCU-300".	

**Australia**

3M Australia Pty. Limited  
Building A, 1 Rivett Road  
North Ryde, N.S.W. 2113  
+61 1800 024 464

**Austria**

3M Österreich GmbH  
Kranichberggasse 4  
1120 Wien  
+43 01 86686 0

**Belgium**

3M Belgium N.V. / S.A.  
Hermeslaan 7  
1831 Diegem  
+32 2 722 51 11

**Czech Republic**

3M Česko, spol. s r. o.  
V Parku 2343/24  
148 00 Praha 4  
+420 261 380 111

**Denmark**

3M Denmark a/s  
Hannemanns Allé 53  
DK 2300 København S  
+45 43 48 01 00

**Estonia**

3M Eesti OÜ  
Pärnu mnt. 158  
11317 Tallinn  
+372 6 115 900

**Finland**

Suomen 3M Oy  
Keilaranta 6  
PL 600  
02151 ESPOO  
+358 9 525 21

**France**

Siège social 3M en France  
1 Parvis de l'Innovation  
CS 20203  
95006  
Cergy-Pontoise cedex  
+33 1 30 31 61 61

**Germany**

3M Deutschland GmbH  
Carl-Schurz-Str. 1  
41460 Neuss  
+49 2131 140

**United Kingdom**

3M United Kingdom  
PLC3M Centre,  
Cain Road,  
Bracknell,  
RG12 8HT  
+44 870 60 800 60

**Greece**

3M Hellas Limited  
Κηφισίας 20  
151 25 Μαρούσι,  
Αθήνα-Μαρούσι  
+30 210 68 85 300

**Hungary**

3M Hungária Kft.  
1117 Budapest  
Neumann J. u. 1/E.  
+36 1 270 7777

**Ireland**

3M Ireland Limited  
The Iveagh Building  
Carrickmines Park  
Carrickmines  
Dublin 18 D18 X015  
+353 1 280 3555

**Israel**

שרא לוב ע"מ 3M ר ה'מדינת תהיהוד  
91 ת.ד.4220 הרצליה

**Italy**

3M Italia Srl  
Sede 3M Malaspina  
via N. Bobbio 21  
20096 Pioltello (MI)  
+39 800 802145

**Latvia**

3M Latvija  
K.Ulmaņa gatve 5  
Rīga, LV-1004  
+371 67 066 120

**Lithuania**

3M Lietuva, UAB  
A. Goštauto g. 40A  
LT-03163 Vilnius  
+370 5 216 07 80

**Netherlands**

3M Nederland B.V.  
Molengraaffsingel 29  
2629 JD Delft  
+31 15 78 22 333

**New Zealand**

3M New Zealand Limited  
94 Apollo Drive, Rosedale  
AUCKLAND 0632  
+64 (0)800 364 357

**Norway**

3M Norge AS,  
Tærudgata 16  
2004 Lillestrøm  
+47 063 84

**Poland**

3M Poland Sp. z o.o.  
Aleja Katowicka 117, 05-830  
Nadarzyn  
Kajetany K. Warszawy  
+48 22 739 60 00

**Portugal**

3M Portugal Lda  
Edificio Office Oriente  
Rua do Mar da China Nº3 - 3º  
Piso A  
1990-138 Lisboa  
+351 21 313 4606

**Slovakia**

3M Slovakia Representation  
Office  
Obchodné zastupiteľstvo  
Vajnorská 142  
831 04 Bratislava  
+421 2 491 05 211

**South Africa**

3M South Africa  
146a Kelvin Drive, Woodmead,  
2196  
+27 011 806 2000

**Spain**

3M España,  
S.A.Juan Ignacio Luca de Tena  
19-25  
28027 Madrid  
+34 91 321 60 00

**Singapore**

3M Singapore Pte Ltd  
3M Technologies (Singapore)  
Pte Ltd  
1 Yishun Avenue 7  
Singapore 768923  
(65) 6450 8888 (Yishun)

**Sweden**

3M Svenska AB  
Bollstanäsvägen 3  
191 89 Sollentuna  
+46 8 92 21 00

**Switzerland**

3M (Schweiz) AG  
Eggstrasse 93,  
Postfach 8803 Rüslikon  
+41 44 724 90 90

**Turkey**

3M Sanayi ve Ticaret A.Ş  
Şehit Sinan Eroğlu Cad  
Suryapı Akel İş Merkezi No:6  
A Blok Kavacık Beykoz  
34805 İstanbul  
(90) 216 538 07 77

**United Arab Emirates**

3M Gulf Ltd  
P.O. Box 20191 Building 11,  
Third Floor, Dubai Internet City,  
Deira  
+ 971 4 367 0777





### **3M Personal Safety Division**

3M Svenska AB, Box 2341  
SE-331 02 Värnamo, Sweden  
Website: [www.3M.com/PELTOR](http://www.3M.com/PELTOR)  
E-mail: [cstechservice@mmm.com](mailto:cstechservice@mmm.com)

3M Center St. Paul, MN 55144-1000

FOR MORE INFORMATION

In United States, contact:

Website: [www.3M.com/PELTOR](http://www.3M.com/PELTOR)  
Technical Assistance: 1-800-665-2942  
Website: [PELTOR.comms@mmm.com](mailto:PELTOR.comms@mmm.com)

In Canada, contact: 1-855-484-3093

Website: [PELTOR.comms.canada@mmm.com](mailto:PELTOR.comms.canada@mmm.com)

For other 3M products:

1-800-3M-HELPS or 1-651-737-6501

3M Australia Pty Ltd  
Bldg A, 1 Rivett Rd,  
North Ryde, NSW 2113  
Customer Service: 1300 363 565  
TechAssist Helpline: 1800 024 464  
E-mail: [techassist@mmmcom.au](mailto:techassist@mmmcom.au)  
Website: [www.3M.com/au/PPESafety](http://www.3M.com/au/PPESafety)

3M New Zealand Ltd  
94 Apollo Drive, Rosedale, 0632  
Customer Service: 0800 252 627  
TechAssist Helpline: 0800 364 357  
Website: [www.3M.com/nz/PPESafety](http://www.3M.com/nz/PPESafety)

### **FP3874REVB**

© 3M 2020. All rights reserved.  
Please recycle.

3M is a trademark of 3M Company,  
used under license in Canada.  
PELTOR is a trademark of 3M Company,  
used under license in Canada.

Patent: [www.3M.com/patent](http://www.3M.com/patent)  
3M Personal Safety Division products are for  
occupational use only.